

Trials

Standing Regulations

TRIALS	204
ACU BRITISH RT KEEDWELL GROUP ADULT AND YOUTH A SOLO TRIALS CHAMPIONSHIP	218
ACU WESSEX PLANT HIRE BRITISH SIDECAR TRIALS CHAMPIONSHIP	221
ACU S3 PARTS NATIONAL TRIALS CHAMPIONSHIP	223
ACU NORMANDEALE TRADITIONAL TRIALS CHAMPIONSHIP	225
ACU SAMMY MILLER TRIAL CHAMPIONSHIP	227
ACU OSET BRITISH SOLO YOUTH TRIALS CHAMPIONSHIP	229
ACU BRITISH LADIES AND GIRLS TRIALS CHAMPIONSHIPS	231
ACU TRAIL BIKE SERIES INCORPORATING THE ACU TRAIL BIKE CHAMPIONSHIP	233
TRIALS – MACHINE EXAMINER’S CHECK LIST	234
TRIALS OFFICIALS	235
ARENA TRIALS	236
ATV TRIALS	237
BICYCLE TRIALS	238

The National Sporting Code of the ACU and these Standing Regulations shall apply to all Trials together with the Supplementary Regulations and any Final Instructions issued for individual events.

DESCRIPTION

A Trial is a test of riding skill and balance over a variety of observed obstacles with riders incurring penalties for footing or for failing to fulfil other conditions.

INFORMATION REGARDING AUTHORISATION AND LAND USE

Most events depend on goodwill from landowners, local authorities, nearby residents and other users of the countryside. For the continuance of orderly motorcycle sport, a Code, formulated by LARA has been adopted by the ACU. The Code for events with no speed element is reproduced below and will supplement the Standing Regulations. It is to be noted that where necessary disciplinary action will be taken if the Code is not fulfilled.

- 1 Any competitive event that is routed along, or across, footpaths or bridleways must be endorsed in advance by the Highways Authority for the area, unless the route of the event is on a highway of higher status.
- 2 The Organiser is responsible for obtaining authority from the landowners over whose the event passes, unless the route of the event is on a highway of higher status.
- 3 Where the event requires use of public highway, organisers must ensure that the Motor Vehicles (Competitions and Trials) Regulations 1969 are strictly adhered to. Events requiring authorisation must obtain this through the RAC Motor Sports Association, Authorisation Dept.
- 4 The Organiser is responsible for ensuring the event meets all requirements of the Road Traffic Act 1988 and the Statutory Instruments made thereunder.
- 5 The regulations, final instructions of an event should display the following sign: "This event is routed along and/or across public rights of way. Competitors must exercise caution and reduce their speed accordingly near other path users. Be especially careful near horses. Slow down, stop and switch off your engine if necessary".
- 6 The Organiser should appoint an officer responsible for event liaison. The Liaison Officer should, if appointed submit his name and address to the local Highway Authority, the Parish Council, the Police and landowners over whose land the event passes. The Liaison Officer will thoroughly investigate any complaints and try to resolve any problems arising from the event.
- 7 Wherever possible the Liaison Officer should maintain good relations with other path users in the area such as horse-riders, walkers, cyclists, recreational motoring groups and orienteers. The Liaison Officer should notify these groups in advance of an event where they are known to him.
- 8 All competitors must follow the Country Code.
- 9 Ensure that all aspects of the ACU Environmental Code are adhered to.

10 **Emergency information**

Supplementary regulations should include either a map reference or a postcode relating to the venue in order to assist the Emergency services.

NB In addition it is recommended that the map reference, farm name, address and postcode should be available at each Section together with the Mobile telephone number of the Secretary of the Meeting. The preferred method is to have this information on a card encased in a plastic wallet on a lanyard. Examples of these are available from ACU Offices.

Dogs

At some venues Dogs may be prohibited. Where they are allowed, they are to be kept under control and owners are responsible for clearing up any fouling which may occur.

TSR1 ELIGIBILITY/LICENCING

All riders and passengers must hold a current ACU/SACU Trials Registration card . Any rider or passenger from another FMN MUST produce a licence issued by their FMN together with start permission and proof of personal accident Insurance.

Where the Trial includes the use of public highways, then this will be stated in the Supplementary Regulations. If public highways are used then it is the sole responsibility of the rider to ensure that their machine is roadworthy and that they and their machine comply with all legal requirements.

RIDERS/MINDERS/ASSISTANTS AGE

- a) **Adult riders:** A rider must be at least 16 years of age to participate as an Adult.
- b) **Sidecar passengers:** In principle a Sidecar passenger must be an Adult however riders may be allowed to compete in Adult events subject to the discretion of the Trials and Enduro Committee.
- c) **Youth Riders:** A rider must be at least 4 years of age to participate on an Electric powered machine and 6 years of age to participate in a trial using a combustion engine machine. After their 16th birthday a rider may compete as an Adult or as an A Class Youth until the end of the calendar year that they reach 17yrs and may alternate (on an event to event basis) between Youth and Adult classes subject to the following:

- whilst riding as an A Class Youth the rider is restricted to machines of an A Class Youth
- whilst riding as an Adult, capacity restrictions do not apply.

Any rider who competes as an Adult in the Championship Class of the Adult British Solo Trials Championship relinquishes the possibility to revert to Youth in the future.

- d) **Minders/Assistants:** In events where Minder/Assistants are allowed, their minimum age must be 18 yrs.

YOUTH AGE GROUPS

- A Class born between 01.01. 1998 and 31.12.1999
- B Class born between 01.01. 2000 and 31.12.2002
- C Class born between 01.01. 2003 and 31.12.2005
- D Class born between 01.01.2006 and 31.12.2009

Note: To ride a Combustion engined machine the rider must have attained 6yrs.

E Class Minimum age – 4 years and born after 01.01.2010

Note: The rider must have attained 4 years at the date of the competition.

ENGINE CAPACITY /WHEEL SIZE FOR ABOVE AGE GROUPS:

The maximum permitted for machines used in the Age Groups set out in this Regulation are as follows:

- A Class 125cc Mono or 250cc Twinshock combustion engine, and Electric up to 10bhp measured at the rear wheel.
 - B Class 125cc Mono or 250cc Twinshock combustion engine, and Electric up to 10bhp measured at the rear wheel
 - C Class 80cc combustion engine, and Electric up to 7bhp measured at the rear wheel.
 - D Class 80cc combustion engine, Maximum Medium wheel. and Electric up to 7bhp measured at the rear wheel
 - E Class Small wheel Electric powered machines up to 2bhp measured at the rear wheel.
- The C and D Classes may be split by wheel size.
- C Class Standard Wheel.
 Medium Wheel
 - D Class Medium Wheel
 Small Wheel

Wheel sizes

Standard Wheel – 21" Front – 18" Rear

Medium Wheel – 19" Front – 17" Rear

Small Wheel – 16" Front – 14" Rear

The above is based on the wheels of combustion engined machines using motorcycle tyres. If other wheels are used as on current Electric powered machines then the outside diameter (total circumference) of the tyre must not exceed that of the corresponding tyre size

Engine Sizes

Rebores are permitted subject to the resulting engine capacity not exceeding a tolerance of +3cc.

Criteria for riders wishing to ride in any higher class:

- Events below National status – a rider may compete in any class higher than that of his/her age group at the discretion of the organizers.
- National status competitions – a rider may at the discretion of the Trials and Enduro Committee be permitted to ride in the higher class. Written application supported by written approval from the riders Centre must support such a request.

Criteria for riders wishing to ride in any lower class:

- A rider may enter any event in a class below that of his/her age group on a “no award, no points” basis.

In all cases the rider must always comply with the maximum capacity and wheel size for their actual age.

TIME AND OBSERVATION RULES FOR YOUTH TRIALS (A & B CLASS RIDERS)

- 1 Qualified First Aid Personnel with equipment and transport must be in attendance.
- 2 The course must be marked in such a manner that excludes sharp corners and blind bends wherever possible.
- 3 Travelling Marshals will be provided to give at least one per two miles of course.
- 4 The Regulations must include the note “This Event is not recommended for Novice Riders”.
- 5 The general public are to be discouraged from entering the area of the course.
- 6 Any other Youth class riders are only allowed to participate after prior approval of the Trials and Enduro Committee.
- 7 A Steward appointed either from ACU Headquarters or from the Local Centre should be in attendance.

TSR2 ENTRIES

An Event Entry Form must be completed in every detail, and signed by each rider and passenger.

Each completed entry form, together with the entry fee (which includes riders/passengers insurance premiums for personal accident and off road risks) and Entry Subscription (see NSC 7.05) shall be forwarded to the Secretary of the Meeting. Where third party insurance cover to meet RTA requirements on the Public Highway is offered by the organiser, this will be at a supplementary cost. All riders, passengers and appointed persons responsible for minors, must register arrival at an event by signing-on at the event control office, or other designated area, not less than 30 minutes prior to commencement of the competition.

Riders and Passengers under 18 years of age (Minors): In order to conform with the Children Act legislation, additionally, for every rider or passenger who is under 18 years of age a Parental Agreement must be signed. The Parental Agreement is incorporated in the Annual Competition Licence and Trials Registration form and once completed will serve as the riders Annual Parental Agreement. All minors will be bound by the directions of parent(s), guardian(s) or other appointed adult responsible for them at any event. The following guidelines apply:

Minors Under 14 The Parental Agreement must be signed by a parent or legal guardian who must also be present when the rider competes.

Minors Aged 14 or 15 The Parental Agreement must be signed by a parent or legal guardian who must also be present when the rider competes unless they have specified another responsible adult who may sign for and accompany the rider at events.

Minors Aged 16 or 17 The Parental Agreement must be signed by a parent or legal guardian. There is no requirement for the minor to be accompanied to events by an adult.

Child Protection: The point of contact for Child Protection issues will be the Secretary of the Meeting unless otherwise stated in the Supplementary Regulations.

TSR3 LIMITATION OF ENTRIES

Any limitation on the maximum or minimum number of entries to be accepted, together with the method of limitation (e.g. in order of receipt, by ballot, etc.) must be included in the Supplementary Regulations.

TSR4 WARNING NOTICES

Organisers should display Warning Notices at the event, recommended to be placed at any point of the course where the public is likely to congregate

TSR5 TEAM NOMINATIONS

TEAM-ONLY COMPETITIONS (E.G. INTER CENTRE).

All riders and passengers must sign an entry form and all entries must be made via an appointed Team Manager.

TRIALS INCORPORATING COMPETITION FOR TEAMS.

Teams shall consist of riders who have entered individually and such riders must complete a declaration on the entry form signifying their consent to nomination as a team member.

TYPE OF TEAM

- a) **Club Teams.** A rider must be a registered member of the nominating Club and may be nominated as a member of one Club Team only.
- b) **One Make of Manufacturers' Teams.** Teams shall consist of riders all riding machines of the same manufacturer.

Details of further teams if any shall be contained in the Supplementary Regulations.

TSR6 CHANGE OF RIDER

All entries will be deemed to be in respect of the rider so named and no change of rider will be permitted except in the case of "Team Only" competitions where the Team Entry is submitted by a Team Manager. For "Team Only" competitions any change of an individual entry will be subject to the conditions of the Supplementary Regulations.

TSR7 CHANGE OF MACHINE AND/OR PASSENGER

Any request for change of machine and/or passenger must be made in writing and submitted to the Secretary of the Meeting at least one hour prior to the start of the event. The same machine must be used throughout the event. In the case of a sidecar this is deemed to be an integral part of the machine.

TSR8 MOTORCYCLES

Motorcycles must comply with Appendix D of the National Sporting Code. Prior to the start of each Event all machines shall be examined to ensure that they comply with ACU specifications. When the event uses the public highway it is the sole responsibility of the rider to present a machine complying with all Road Traffic Act(s) requirements Organisers may at their discretion, allow riders to share the same machine in a Closed to Club Trial held on private land.

SOLO: Motorcycles propelled by the action of one wheel in contact with the ground and making only one track on the ground. Machines must have independent brakes on both front and rear wheels.

Brake and Clutch levers. All handlebar levers (clutch, brake etc.) must be in principle ball ended.

These ends must be permanently fixed and form an integral part of the lever

Mudguards must be fit for purpose and corresponding to the original equipment.

Footrests must be of the folding type.

Throttle must be self closing when not held by the hand. The machine may be set with a "tickover".

Wheels If of cast, or fabricated construction (other than conventional spoked wheels) then protection must be provided to the rear wheel by the fitting of 'solid discs' to cover open areas.

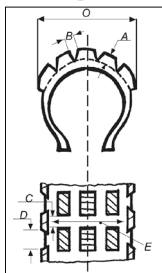

Tyres. Only tyres which conform to the following specification may be used. All tyres will be measured mounted on the rim inflated to a pressure of 14 lbs/sq.in, and must have a nominal aspect ratio of 100/100. Overall width (O) measured at wheel spindle height must not exceed 115mm. (Refer to diagram). Tread depth (A) must not exceed 13mm. All tread blocks in the same circumference must be of the same depth. The space between the tread blocks (B) must not exceed 9.5mm across the tyre or 13mm in a circumferential direction (C). The space between the shoulder blocks (D) must not exceed 22mm. The space across the tread (E) must not extend completely across the tyre measured at right angles to the tyre wall unless broken by a block. All main tread blocks must in principle be parallel with or at right angles to the tyre axis. (Tyre must have the same appearance if reversed and conform in principle with these diagrams). The tyre

surface must not be fitted with any subsequently mounted elements such as anti-skid devices, chains, etc. NB: Only tyres available from commercial sources and complying with these dimensions are permitted in competitions. Where the event uses the public highway, tyres must be manufactured to comply with European Tyre & Rim Technical Organisation and have the relevant markings.

Tyres for Long distance Trials Only tyres normally available from commercial or retail sources for use on the public highway (specification as above under "Tyres") are authorised. They shall appear on the tyre manufacturers range catalogue or tyre specification list available to the general public. They must be manufactured to comply with European Tyre and Rim Technical Organisation (ETRTO) requirements in respect of load and speed codes and have a minimum service description of 45M.

The use of MX and Enduro-type tread patterns are not permitted. The space between adjacent tread blocks must in principal not exceed 15mm (distance between tread block corners at diagonal groove intersections may exceed this dimension).

Cutout Device. All combustion engine machines and Electric machines used by Youth competitors must be fitted with an operational lanyard operated cut out device rigidly connected to the rider by a lanyard (max length 1 metre) so as to stop the engine/ motor should the rider and machine be parted. It is recommended that all combustion engine machines used by Adult riders be fitted with a lanyard operated cut out device.

Chainguards must be fitted to all motorcycles as per manufacturer's specification.

Engine Measurement Where it becomes necessary for the ACU or an organiser to verify any fact relating to an engine size, it shall be carried out at the cost of the rider. Where an engine is measured, as the result of a protest, the protest must be submitted with the appropriate fee plus a deposit of £250.00 which can only be returned if the protest is upheld. If the protest is unsuccessful then the deposit will be awarded to the person against whom the protest has been made and the protest fee will be sent to the ACU Benevolent Fund. The Clerk of the Course shall judge as guilty anyone who refuses to present an engine for measurement. A rider whose machine is found to have an engine size not complying with the rules will be disqualified and will be liable to further disciplinary action. If engines are presented for measurement, but this cannot be carried out at the event, the engines must be sealed for later measurement. If seals are damaged or removed the rider will be disqualified and subject to a fine.

TRIALS SIDECAR SPECIFICATION

All motorcycles in Categories B (1), B (2) and B (3) shall comply with the following requirements:

- a) The entire body, including the floor, shall be either sheet metal or other substantial material, and the Sidecar must be rigidly fixed to the motorcycle
- b) Minimum dimensions shall be:
 - A. Measurement from the nose to dashboard - 450mm (18")
 - B. Overall length nose to tail - 1350mm (54")

- C. The height of the body at the apex of the dashboard position – 375mm (15")
- D. The overall distance between the outside of the Sidecar mudguard or bodywork and the inside of the passenger's seat measured at right angles to the machine track – 300mm (12")
- E. Width of body at forward end – 150mm (6")
- Depth of body at forward end – 150mm (6")
- OR if the forward end is hemispherical and radius shall be not less than 75mm (3")

F. Track – minimum 876mm (34½")

The distance is measured from the centre of the track left by the rear wheel to the centre of the track left by the sidecar wheel.

G. Overall width of cockpit at seating position – 300mm (12")

A seat measuring not less than 180mm (7.5") × 125mm (5") must be fitted. The height of the seat shall be not less than 300mm (12") from the floor of the sidecar.

- c) The fitting of grab rails, handles, straps etc shall be according to the driver's requirements.
- d) Protection for the passenger must be provided from the rear wheel, the primary and final drive of the motorcycle, and from the sidecar wheel, by means of either a mudguard or the coachwork of the sidecar.
- e) The use of sidecar wheel drive is prohibited.

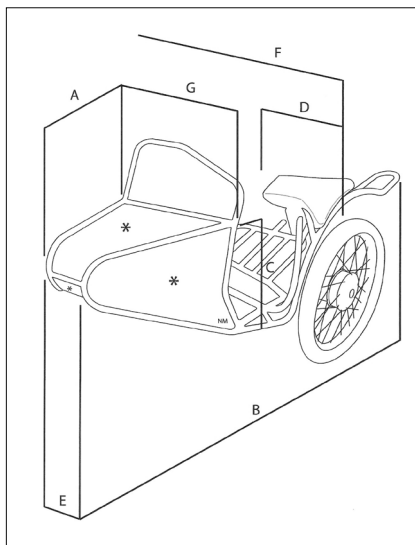

TSR 9 FUEL

Commercially available unleaded fuel must be used. Power boosters or octane boosters are forbidden. Refuelling must not take place when the engine is still running. Mobile Phones must not be used in refuelling areas.

ENVIRONMENTAL MATS

All machines and generators must stand on an Environmental mat whilst being refuelled.

TSR10 TELEMETRY

The use of Telemetry between the rider/motorcycle and any other person/equipment by radio means is not allowed.

TSR11 RIDING NUMBERS

Riding numbers issued by the organisers, whether card or numbered bibs must be clearly displayed in a legible condition throughout the competition. Riding numbers shall not be defaced in any way and no event sponsors advertising shall be covered. Riding numbers shall be removed at the Finish. Where there are different section routes for different classes of rider, each rider shall be issued with a means of identification to reflect the route the competitor is riding.

TSR12 CLOTHING

Clothing must cover legs and body and it is recommended that arms should be covered. Boots of approximately knee length made of leather, rubber or plastic must be worn. The wearing of gloves is recommended.

Motorcycle helmets Competitors, both riders and Sidecar passengers must wear a correctly fitted

helmet whilst riding a motorcycle or quad. Officials must wear a correctly fitted helmet whilst riding a motorcycle, and it is recommended that they wear a helmet whilst riding a quad.

Jewellery Competitors are advised not to wear hand, face or body jewellery which could prove hazardous in the event of an accident. The mouth should be kept clear of anything likely to cause a blockage of the airway in the event of an accident, e.g. chewing gum.

Youth All Youth competitors must have clothing covering arms and wear gloves covering hands and fingers.

TSR13 PILLION PASSENGERS

The carrying of pillion passengers is not allowed except where provision has been made for this in the Supplementary Regulations.

TSR14 CONTROL OF EXHAUST SOUND LEVEL

The sound level of a Trials machine controlled according to the ACU method and measured at 2 metres distance will not exceed 100 dBA (For precise method of testing, see Sound Control Regulations in this Handbook).

There may be one or more random sound level tests during the event for which the rider will not be allowed to make any adjustments. A rider whose machine exceeds the maximum permitted sound level or does not present his machine in a testable condition will face immediate disqualification and must return to the finish as directed. Additionally, at any time during the event, the Clerk of the Course or the appointed official is empowered to disqualify any machine he considers excessively noisy.

TSR15 START AND FINISH

Prior to Starting, the rider must have signed on, had his/her machine examined and be suitably dressed. All riders, including riders who have retired, must report to the Finish where they may be required to sign off. The method of deciding the starting order will be stated in the Supplementary Regulations or, where applicable, in the appropriate Championship Regulations.

TSR16 TIME

For Trials other than Time and Observation Trials, where full details regarding the calculation of time penalties shall be included in the Supplementary Regulations, the following shall apply; if a time restraint is applied to part or all of the Trial, it shall be in the form of an individual allowance for each rider and the details given in the Supplementary Regulations or Final Instructions. Wherever a Time restraint is applied there must be a Clock showing the Official time visible to all riders at each time control point.

A rider's Time Allowance shall commence from the actual time the rider starts. The location of the final Time Control should be at the last section, or as close as practical. Riders will be penalised one mark per minute or part of that minute up to a maximum of twenty for late starting, and for arriving late at any subsequent Time Control, and thereafter disqualified.

It is recommended that the time limit shall not be extended other than in the case of Force Majeure as determined by the Clerk of the Course.

TSR17 COURSE/ROUTE

The Clerk of the Course must ensure that due consideration is given to the age and abilities of the riders when planning and marking the course and that suitable marking is displayed to guide and restrict any spectators/members of the Public who may attend.

The onus of following the correct route rests entirely with the rider. A rider leaving the course must rejoin it at the same point. When public roads are used to connect areas of private land a map clearly showing their position must be displayed at the Start or in the programme. The onus of finding these areas of private land rests entirely upon the rider and any route marking provided by the organisers

is purely for assistance. The Clerk of the Course reserves the right to modify the route. To qualify as a finisher and be eligible for an award, the rider's machine must have travelled the whole distance under its own power or the exertion of the rider and passenger. Any rider, who on any private land is accompanied by another vehicle unconnected with the event, is liable to disqualification. Any competitor who is, in the opinion of the Clerk of the Course, considered to be riding the course for the benefit of another competitor is liable to disqualification and reporting to the Stewards for further disciplinary action.

If route marking is appropriate it is recommended that discs (square, round, etc – not arrows) are used to signify the direction – red for right, blue for left and white to straight on. It is suggested also that where a red or blue disc is used then following the turn, there should be a white to assure the rider that the correct route has been taken.

TSR18 OBSERVED SECTIONS

The organiser must display which route each class is riding indicating the corresponding colours of the route marking. Details may be displayed at signing on, at the first section or contained in the Final Instructions or programme. Riders in the same class must all start at the same section

It is recommended that routes be marked as follows:

Route A – Principal Route – Blue (left) Red (right)

Route B – Yellow both sides

Route C – White both sides

Any further routes to be marked in a colour chosen by the Organiser

In the above, the letters denote the severity of the sections in descending order ie Route A would be hardest, Route B next hardest and so on.

Routes may be marked in their entirety in the colours shown – or the Organiser may mark appropriate diversions in these colours. Ideally – the coloured section of markers should be in the shape of an arrow – with the point toward the centre of the section

No penalty shall be imposed on a rider who wishes to inspect a section before riding it.

The lateral limits of an Observed Section or Sub Section may be defined by artificial boundaries such as markers or tapes, which shall be firmly placed and positioned in a way so as to clearly define the intended limits of the section. If tapes are to be used they shall always be clear of the ground but not exceed a height of 500mm from the ground.

The Start and Finish of each Observed Section or Sub-Section will be clearly defined, with the Section Begins and Section Ends identified as such.

Sections and Sub-Sections shall be numbered or lettered and ridden in the correct sequence unless otherwise instructed by the organisers.

A rider failing in a Sub-Section must restart in a forward direction from the Sub-Section in which he has failed.

To qualify as a Finisher and be eligible for an award, the competitor must be deemed to have made a bona fide attempt at least 75% of the sections.

TSR19 PUNCHCARDS

If punchcards are used, the onus of looking after these rests entirely on the rider and only the rider/passenger may present the punchcard to the observer. Any disagreement over the score punched, or errors must be reported to the Secretary of the Meeting immediately upon completion of the event. The Observer must be informed that this action is being taken as any error not verified by the Observer shall not be accepted. Refusing to have the card punched, deliberately disfiguring or losing the punch card will result in disqualification for which no protest will be accepted. Any rider who does not return his punchcard to the appointed Official without delay will be classed as retired.

TSR20 OBSERVERS

An Observer is an assistant to the Clerk of the Course appointed to judge a competitor's performance

in an Observed Section. No protest or appeal can be accepted against a judgement of performance made by an Observer, however, a protest may be accepted against any breach, or misinterpretation of the Regulations.

A mistake made by an Observer may be corrected by the Observer with the approval of the Clerk of the Course.

TSR21 INSTRUCTION TO RIDERS

Any instruction to riders not included in the Supplementary Regulations (Final Instructions) must be approved by the permit issuing authority if issued prior to the event, or approved by the Stewards of the meeting if issued at the event.

Subject to being issued in one of the following ways they shall have the same force as these Standing Regulations

- Issued in writing and distributed to each rider
- Issued via a clearly situated notice board
- Via a riders briefing meeting, providing all riders have been informed formally of the venue and time of such a meeting.

TSR22 METHOD OF MARKING

A machine will be deemed to be in an Observed Section or Sub-Section when the front wheel spindle has passed the 'Section Begins' Card and until the front wheel spindle has passed the 'Section Ends' Card. Marks will be lost as follows:

A. STOP PERMITTED

- 0 Clean
- 1 Footing once
- 2 Footing twice
- 3 Footing more than twice
- 5 Failure
- 5 When requested by a rider rather than attempt the section
- 5 Entering a section before being called upon to do so by an official
- 10 Not attempting a section when called upon to do so by an Official
- 10 For missing a section or failing to have punch card marked.

Graded Hills. Where a Section is to be termed a 'Graded Hill' a notice to that effect must be displayed at the Section Begins, and the following shall apply: Numbered boards must be placed at defined places along the Section, in order that a rider's performance may be determined. Marks will be lost in a decreasing manner from 5 to 0 depending on the distance a rider can traverse the Section without failure. The front wheel spindle is the part of the machine to be used in assessing the distance traversed.

- 0 Clean
- 1 Reaching or passing the "1 Board" without Failure.
- 2 Reaching or passing the "2 Board" without Failure.
- 3 Reaching or passing the "3 Board" without Failure.
- 5 Failure to reach the "3 Board".
- 5 When requested by a rider rather than attempt the section
- 10 Not attempting a Section when called upon to do so by an Official
- 10 For missing a section or failing to have punch card marked.

DEFINITIONS

Clean: A rider traversing a Section as defined above without penalty as described under FOOTING or FAILURE shall be unpenalised and given a "CLEAN".

Footing: Footing will be considered to have occurred if any part of the rider's body or any part of the machine, (with the exception of the tyres or the sump shield) touches the ground or the rider benefit

from any part of their body, or any part of the machine, (with the exception of the tyres or the sump shield) leaning on an obstacle (tree, wall etc.)

Footing outside the lateral limits of a Section does not constitute a failure but should simply be classed as footing.

Failure: A failure is considered to have occurred if:

- a) The machine moves backwards.
- b) The rider does not have both hands on the handlebar WHEN HE FOOTS WHILST STATIONARY.
- c) The engine stops WHILST ANY PART OF THE MACHINE, WITH THE EXCEPTION OF THE TYRES, TOUCHES THE GROUND OR THE RIDER IS FOOTING.
- d) The rider dismounts from the machine. Dismount will be deemed to have occurred when both of the rider's feet are on the ground at the same side of, or behind the machine.
- e) A rider is requested to leave the section by the observer for "unnecessary delay".
- f) A machine does not stay within the intended limits of the section as defined by the Observer.
- g) If any wheel of the machine crosses any boundary tape or goes over or on the wrong side of a marker, whether the wheel be on the ground or airborne, before the front wheel spindle passes the "Section ends" sign.
- h) The rider is held responsible for displacing a marker or support in an observed section whereby the observer considers it necessary to reinstate the flag/marker prior to the passage of the next rider
The displacing of any marking not relating to the competitor's route will be considered to constitute a failure.
- i) Travelling in a forward direction against the direction of the Section.
- j) The motorcycle crosses its own track with either wheel.
- k) The machine or rider receives outside assistance.
- l) A rider or person having an interest in a rider's performance, who in any way alters the severity of a section without the authority of an official.

For all trials other than those for which Championship Regulations apply the organiser may, with the agreement of the Permit Issuing Authority, apply a time limit to each section. The time allowed must be the same for each and every Section and the penalty for a rider not completing the Section within that time would be failure. If a time limit is to be applied to the Sections then this must be clearly stated in the Supplementary Regulations.

B. NON-STOP (SOLO & SIDECAR)

- 0 Clean
- 1 Footing once
- 2 Footing twice
- 3 Footing more than twice
- 5 Failure
- 5 When requested by a rider rather than attempt the section
- 5 Entering a section before being called upon to do so by an official
- 10 Not attempting a section when called upon to do so by an Official
- 10 For missing a section or failing to have punch card marked.

Graded Hills. Where a Section is to be termed a 'Graded Hill' a notice to that effect must be displayed at the Section Begins, and the following shall apply: Numbered boards must be placed at defined places along the Section, in order that a rider's performance may be determined. Marks will be lost in a decreasing manner from 5 to 0 depending on the distance a rider can traverse the Section without failure. The front wheel spindle is the part of the machine to be used in assessing the distance traversed.

- 0 Clean
- 1 Reaching or passing the "1 Board" without Failure.
- 2 Reaching or passing the "2 Board" without Failure.

- 3 Reaching or passing the “3 Board” without Failure.
- 5 Failure to reach the “3 Board”.
- 5 When requested by a rider rather than attempt the section
- 10 Not attempting a Section when called upon to do so by an Official
- 10 For missing a section or failing to have punch card marked.

DEFINITIONS

Clean: A rider traversing a Section as defined above without penalty as described under FOOTING or FAILURE shall be unpenalised and given a “CLEAN”.

Footing: Footing will be considered to have occurred if any part of the rider’s body or any part of the machine, (with the exception of the tyres or the sump shield) touches the ground or the rider benefit from any part of their body, or any part of the machine, (with the exception of the tyres or the sump shield) leaning on an obstacle (tree, wall etc.),

Footing outside the lateral limits of a Section does not constitute a failure but should simply be classed as footing.

Failure: A failure is considered to have occurred if:

- i) The machine ceases to move in a forward direction.
- ii) The rider dismounts from the machine. Dismount will be deemed to have occurred when both of the rider’s feet are on the ground at the same side of or behind the machine.
- iii) A machine does not stay within the intended limits of the section as defined by the Observer.
- iv) If any wheel of the machine crosses any boundary tape or goes over or the wrong side of a marker, whether the wheel be on the ground or airborne, before the front wheel spindle passes the “Section ends” sign.
- v) The rider or passenger is held responsible for displacing any marker or support in an observed section whereby the observer considers it necessary to reinstate the flag/marker prior to the passage of the next rider
The displacement of any marking not relating to the competitor’s route will also be considered to warrant a failure
- vi) The machine or rider travels in a forward direction against the direction of the Section.
- vii) The motorcycle crosses its own track with either wheel
- viii) The machine, or rider or passenger receives outside assistance.
- ix) A rider or person having an interest in a rider’s performance, in any way alters the severity of a section without the authority of an official.

For Sidecar events only.

A failure is considered to have occurred if:

The passenger foots i.e. if any part of the passenger’s body touches the ground, or benefit is gained from any part of his body leaning on an obstacle (tree, wall etc.).

TSR23 TIES

A) Ties in an Event

Ties will be resolved by the following method in the sequence shown

- a) In favour of the rider with the highest number of cleans.
- b) In favour of the rider with the highest number of one mark.
- c) In favour of the rider with the highest number of two marks.
- d) In favour of the rider with the highest number of three marks.
- e) In favour of the rider who travelled furthest with the least marks lost.
- f) In favour of the rider who completes the course with the least marks lost on time.

If not resolved by the above **and the organiser has stated so in the Supplementary Regulations** then a special test may be used for final deciding of ties.

If the event is part of a Championship and if a tie cannot be resolved in accordance with the above

those involved in the tie will be allocated the Championship points of the highest place for which the tie exists.

B) Ties at the end of a Championship Series.

Should a tie occur in a Championship series it shall be decided as follows:

- a) In favour of the rider with the greatest number of wins in ALL rounds held.
- b) If not resolved then the greatest number of second places and so on down to 15th place in ALL rounds held.
- c) If not then resolved, by the rider with the best performance in the final event held

TSR24 FINAL ASSESSMENT OF CHAMPIONSHIPS

The Championship Regulations for any Championship must state the number of rounds to count for the Final Assessment eg: "All rounds to count" or "All rounds held less one, or all rounds less two to count". If no indication is stated then it will be assumed that all rounds held will count.

TSR25 BAULK

A baulk is deemed to have occurred when a rider, whilst attempting an observed section, is prevented from making a bona-fide attempt due to some outside obstruction. Should a rider claim a baulk, the Observer may, at his discretion, allow a re-run of the section. The Observer's decision as to whether a re-run is permitted is final. Should a re-run be granted, any marks lost prior to the point of the baulk on the original attempt shall stand, and the section shall be observed from the point of the baulk. Regarding any time allowed for the section the re-run shall start from the Section Begins and the time will be measured for the total section as if no obstruction had taken place.

TSR26 PRACTISING

Unofficial practising at the venue is prohibited. A breach of this regulation renders the rider liable to disqualification from the event and to be reported to the stewards of the meeting for disciplinary action. If official practice is to be allowed, either in a suitable area away from the paddock, or on the sections to be used, then full details must be stated in the Supplementary Regulations or relevant Championship Regulations.

Where another event takes place at the same venue it will not be considered to constitute unofficial practice.

TSR27 PREJUDICIAL ACTION

Any person having an interest in a rider's performance, who takes any action prejudicial to the sport may result in the disqualification of that rider. Riders, parents or associates failing to obey instructions given by officials of a meeting or deemed to have unjustifiably or maliciously jeopardised the efficient running of the meeting by not adhering to the Regulations, Supplementary Regulations or the Protest or appeal procedure, may render the rider liable for disqualification and/or being reported to the permit issuing authority for further action.

TSR28 LEGAL ACTION

A rider who is convicted following a police prosecution for an offence committed by them whilst taking part in the competition may be liable to disqualification.

TSR29 INSURANCE

The organisers will be required to cover riders and passengers against Personal Accident risk and for Third Party Insurance for 'off-the-road' risks whilst taking part in the event and the premium for such insurance will be included in the entry fee. Where the Trial involves the use of Public Highways each rider will be required to declare that there will be in force in relation to the use of the vehicle which they intend to ride during the event such a policy of insurance or such a security in respect of third part risks as complies with the requirements of the current Road Traffic Acts. Where the organiser

wishes to offer (through the ACU Insurance Broker), Third Party Insurance cover necessary to meet the Road Traffic Act requirements on Public Highways, this must be stated in the Supplementary Regulations. It is the rider's responsibility to request this insurance, complete the necessary forms and pay the required premium.

TSR30 ABANDONMENT

The organisers reserve the right, subject to the approval of the Stewards of the Meeting, to cancel, postpone or abandon the competition, if circumstances should arise which in their opinion, render such action necessary.

TSR31 MEDICAL SERVICES

It is recommended that a person holding a certificate of First Aid competency be present at all events. In addition it is recommended that the organiser shall be conversant with the nearest Accident/Emergency Services and ensure they have a means of contacting them. Organisers must also refer to the "Medical Services and Definition" section of this Handbook.

TSR32 LIABILITY FOR DAMAGE

A rider is liable for any damage caused by themselves, their passenger, or any agent, representative or servant acting on their behalf, during the meeting. The promoters may act as agents for such persons to agree and pay for any such damage, and the rider shall on demand reimburse the promoters any sum so paid.

TSR33 DISCLAIMER

It is condition of acceptance of entry that the promoters shall not be responsible for any damage to, or loss of a motorcycle or its accessories whether by fire, accident or any agent, representative or servant acting on their behalf, during the meeting.

TSR34 OFFENSIVE BEHAVIOUR

Any rider, or party with an interest in a rider's performance, reported to the Clerk of the Course for arguing or being offensive to an Observer, or other Official, renders that rider liable to disciplinary action. Where the Organiser supplies the Observer with a Yellow Card, the Observer may issue it to any rider who continues to hassle or abuse the Observer following a warning. Any rider who is issued a Yellow card will be reported to the Clerk of the Course who may issue further disciplinary action. The Organiser must report to the T&E Committee all incidents where disciplinary action has been taken for Offensive Behaviour.

TSR35 YOUTH AWARDS

Cash awards and gift vouchers are not permitted for Youth classes.

TSR36 JOINT ADULT/YOUTH EVENTS

Subject to the agreement of the Permit issuing Authority a Youth Class/Classes may be included in Adult events. Youths to ride the route as decided by the Clerk of the Course. A Youth must ride a machine of a maximum capacity/power and wheel size as appropriate to their age. Adults and Youths must compete for separate awards.

TSR37 COMPLIANCE WITH REGULATIONS

Every rider, by entering or being nominated, thereby acknowledges that he is bound by the National Sporting Code of the ACU and these Standing Regulations together with any Supplementary Regulations and Final Instructions to be hereafter issued, to all of which he undertakes to submit and moreover renounces any right to have recourse to any arbitration or tribunal not provided for in the said Rules and Regulations.

TSR38 RESULTS

For each event a set of Results must be produced which display the event date and Permit number. The method to be used for the publication of the results must be shown in the Supplementary Regulations or the Championship Regulations.

For every event a set of provisional results must be sent, either by post or by email, to the Permit issuing authority. If these provisional results are amended then a copy of the revised set, clearly marked "Amended (date)" must be sent by post or email to the Permit Issuing authority and any rider affected by the amendment.

TSR 39 PROTESTS

See Appendix B of this Handbook

Where it has been previously stated in the Championship Regulations or Supplementary Regulations and the full results are displayed, signed by the Clerk of the Course (or appointed official) with the time of day, on a board within 30 minutes of the last rider finishing any protest must be submitted within 30 minutes of the time of signing.

Where results are sent by post, sent by email or published on a web-site any protest must be submitted within 14 days of publication. The date of publication of results on a Web site or by email should be shown on the results, or confirmed by postmark if mailed and the Protest period will commence from this date.

Protest against the Capacity/power of a motorcycle must be accompanied by a deposit of £250 to cover associated costs.

TSR40 INTERPRETATION

The interpretation of these Standing Regulations and the Supplementary Regulations or Instructions to rider will rest entirely with the Stewards of the Meeting whose decision shall be final and binding except as provided in the National Sporting Code.

TSR41 POWER WASHERS

It is prohibited to use power washers, unless the organisers offer suitable facilities which comply with the ACU Environmental Code.

TSR42 FIRE EXTINGUISHERS

There shall be at least one fire extinguisher at the start of each event and at any subsequent designated refuelling areas. (Mobile phones must not be used in designated refuelling areas).

ACU British RT Keedwell Group Adult and Youth A Solo Trials Championship

The ACU has established the British Solo Trials Championship and the British Solo Trials Expert Championship. Each will be organised according to the National Sporting Code, the Standing Regulations for Trials, these Championship Regulations and the Supplementary Regulations issued for each event.

1. **Qualifying Meetings.** The list of events may be found in the ACU Fixture List and each event shall include:-
Machine Examination and Administrative controls, The Trial and Prize Presentation.
If a two day Event each day shall be classed as separate with awards and points for each day.
2. **Method of Marking.** TSR 22B.
3. **Eligibility.** All riders must hold an ACU Trial Registration Card or a Licence issued by the SACU. Riders from other Federations must be in possession of a release paper from their Federation and proof of Insurance.
Championship Class: Riders wishing to compete in the Championship Class must register with, and be accepted by, the ACU Trials and Enduro Committee. A rider registered for the Championship Class wishing to change class must seek the approval of the T&E Committee at least 5 days prior to an event or ride on a No Award & No Points basis.
Within the Championship there will be a 125cc Championship for riders competing on a machine not exceeding 125cc.
A Class Youth Championship: This Championship is open to:-
 - All A Class Youth riders.
 - B Class Youths who are in their final year of B Class
 - B Class Youths who finished in the first three places of the 2014 B Class Championship.
 B Class Youths eligible, as above, must apply to the ACU for authorisation to ride in this Championship as an alternative to riding in the B Class Championship.
Expert Class Championship: Open to all other adult riders.
4. **Entries.** The entry for each Event shall be made up of entered riders in the priority as follows:
 - “Championship Class” – Riders on the published list issued by the T&E Committee.
 - “A Class Championship” – A Class riders plus B Class riders authorised by the ACU T&E Committee.
 - “Expert Class” – Expert riders:
 Any entry once accepted by the organiser renders the rider eligible for awards and Championship points
A rider having ridden in one class during the current year may only change class by agreement with the T&E Committee. and then only on a “no points” basis.
5. **Entry Fee.** The entry fee shall be £40.00 per day.
6. **Riders Numbers.** All riders must remove the front light so that they can attach a number board. Rider’s allocated permanent numbers in the Championship Class may produce their own front number board providing it is to the exact specification as laid down in a document available from the ACU Secretariat. All other riders must use the Number Board supplied without modification in any way.
The Championship Class leader in each Class will use a board with a background to signify his position.
7. **Punchcards.** The use of punchcards is obligatory.

8. **Course.** The Course will consist of 3 laps of 12 sections.
9. **Sections.** Each Section shall be independent of other sections and consist of natural terrain. No sections using man made items are allowed. The Sections shall be bounded with tape and flags/markers used to identify the two routes. There shall be one route for the Championship Class and an alternative route marked in different colour for the Expert and Youth Classes. For an event with two days the Clerk of the Course may use different or modified sections for day two.
10. **Practice.** There will not be a practice lap.
11. **Starting Order.** Each rider shall draw his starting order by ballot as follows:

First Round:

Championship Class riders in the first 8 positions of the Classification of previous Year.	Group A
All other Championship Class riders.	Group B
Youth A Class riders by a single ballot.	Group D
Expert riders and all Youth Riders by single ballot	Group F

Starting Order will be Group F followed by C and finally Group A.

Subsequent Rounds:

Championship Class riders placed in the first 8 positions of the current Classification	Group A
Remaining Championship Class riders	Group B
Youth A Class riders placed in the first 8 positions of the current Classification	Group C
Remaining Youth A Class riders	Group D
Expert Class riders placed in the first 8 positions of the current Classification	Group E
Remaining Expert Class riders and All Youth Class riders	Group F

The Starting Order will be Group F followed by E, D, C, B and finally Group A
 The Ballot for starting order will close ½ hour before the Trial Start Time. Any rider who has not drawn his start time by this time must accept the start time given.
12. **Starting Intervals.** Starting shall be at intervals of 1 minute
13. **Cut Out Device:** All competitors must have cut out devices rigidly connected to the rider by a lanyard (max length 1 metre) so as to stop the engine should the rider and machine be parted.
14. **Starting Time.** The Trial Start shall start at 09:30am.
15. **Time Allowance.**

The individual time allowance shall be 3 hours for the first lap and 6 hours total time for the trial.

The First Lap and Final Time Control must be located immediately after the final section. The rider is obliged to go directly from the Final Time Control to the Results Recorder. Any rider who does not return his punchcard to the appointed Official without delay will be classed as retired and will be reported to the Stewards of the Meeting for possible disciplinary action.
16. **Assistants.** There will not be any Assistants for this Championship.
17. **Yellow Card.** Each Observer will be issued with a Yellow Card. The Yellow card may be issued to any rider who continues to hassle or abuse the Observer following a warning. Any rider who is issued a Yellow card will receive 5 additional points and be reported to the Clerk of the Course who may issue further disciplinary action.
18. **Whistle Instructions.** Each Observer will be issued with a whistle. The whistle will be blown if the rider has failed the section and is to inform the rider that he must immediately vacate the Section. A rider who disobeys the instruction is liable to be issued with a Yellow Card.
19. **Scorescreen.** A scorescreen showing the performance of all riders shall be prominently displayed at the finish. The time at which the final riders score is posted will be displayed on

- a card together with the words 'Provisional Results'. This time will indicate the start of the official protest period.
20. **Awards.** Awards for each individual day's trial shall be presented to the first three placed riders in the British Championship, A Class Youth and Expert Classes. The Best 125cc rider in the Championship Class shall also each receive an award. These awards shall be presented as soon as practical after the last man has finished.
- The award winners as listed above plus any additional riders invited by the Clerk of the Course, must attend the Prize-Giving Ceremony. If a rider is absent from the Prize-Giving Ceremony, he will be reported to the Trials & Enduro Committee who will impose a fine of £25 which will be confirmed to the rider in writing.
- This fine will only be waived if it can be shown that there was a genuine reason for non-attendance e.g medical or in the case of the Prize Presentation commencing later than 30 minutes after the results were published. The right to waive this fine rests solely with the Trials & Enduro Committee.
21. **Championship Points.** Championship points will only be awarded to British Citizens and will be awarded to each Championship Class for each event on the following scale:
- | | | |
|---------------|---------------|---------------|
| 1st 20 points | 6th 10 points | 11th 5 points |
| 2nd 17 points | 7th 9 points | 12th 4 points |
| 3rd 15 points | 8th 8 points | 13th 3 points |
| 4th 13 points | 9th 7 points | 14th 2 points |
| 5th 11 points | 10th 6 points | 15th 1 point |
- Ties** – if a tie cannot be resolved in accordance with TSR23 those involved in the tie will be allocated the points of the highest place for which the tie exists.
- A rider who has taken Championship points in any class cannot then take points in another class.
22. **Protests.** Protests must be made within 30 minutes of the publication of the results on the Scoreboard displayed at the event.
23. **Final Assessment.** At the conclusion of the Championship, the points for each rider will be added together and the rider with the highest number of points to his credit will be the winner.
- Should a tie occur it is to be resolved in accordance with TSR23 (B)
24. JURISDICTION ON GRANTING A PERMIT TO 'PROMOTE' THE TRIALS AND ENDURO COMMITTEE DOES NOT ABROGATE ITS OVERALL RESPONSIBILITY FOR THE CHAMPIONSHIP SERIES AND MAY IN ITS ABSOLUTE DISCRETION, WITHHOLD POINTS FOR ALL OR PART OF A 'ROUND' INTRODUCING A REPLACEMENT EVENT AT A LATER DATE IF SEEN FIT.

ACU Wessex Plant Hire British Sidecar Trials Championship

These Championship Regulations to apply in addition to the National Sporting Code, Standing Regulations for Trials and the Supplementary Regulations for each event.

Championship points will be awarded to competitors of any Nationality. The title “Wessex Plant Hire ACU British Sidecar Trials Champion” will be awarded to the competitor with the most points who holds British Citizenship. If the competitor with the most points is not a British Citizen, they will be awarded the title of “Wessex Plant Hire British Open Sidecar Trials Champion”. This principle will apply throughout the Championship classes.

- 1 **Title of Event.** All Supplementary Regulations and programmes must include the words “A round of the ACU Wessex Plant Hire British Sidecar Trials Championship”.
- 2 **Series Sponsor.** Where there is a Series Sponsor who provides bibs/riding numbers, these must be used by the rider without alteration or the obscuring of Sponsors’ logo
- 3 **Qualifying meetings.** The list of events will be found in the current ACU Fixture List.
- 4 **Classes.** Class A – British Championship. Class B – ACU Intermediate Championship. Class C – ACU Clubmans Championship. Class D – ACU Newcomer. (A newcomer is classified as a rider who has never competed in the British/ACU Trials Championship on any class of sidecar machine prior to the current year).
The Intermediate Class will ride a 50/50 combination of Championship and Clubmans sections as determined and identified by the Clerk of the Course.
- 5 **Eligibility.** To be eligible for ACU Clubman Championship and ACU Intermediate Championship points, riders must not have won that Championship class in the previous year. Championship class riders may downgrade at the discretion of the Trials and Enduro Committee. Riders not eligible for points (as detailed above) may compete on a no points basis.
- 6 **Entries** Any entry once accepted by the organiser renders the rider eligible for awards and Championship points
Acceptance or Refusal of Entry. The organiser should notify all riders of the position regarding their entry prior to the event.
- 7 **Starting Order.** The organisers shall determine the starting order within each Group by ballot. Group A will comprise of the British Sidecar Championship riders.
Group B will comprise Classes B, C & D. The riders from Group B will start first followed by riders from Group A.
- 8 **Starting Intervals.** All riders must start at one minute intervals.
- 9 **Method of Marking.** The Championship will be held under TSR22B – Non Stop.
- 10 **Time.** If a time restraint is applied to all or part of a Trial, it shall be in the form of an individual Time Allowance for each rider and the details given in the Supplementary Regulations or Final Instructions.
- 11 **Championship Points.** Championship points for each class will be awarded to the top 15 eligible finishers in each round on the following scale:

1st 20 points	6th 10 points	11th 5 points
2nd 17 points	7th 9 points	12th 4 points
3rd 15 points	8th 8 points	13th 3 points
4th 13 points	9th 7 points	14th 2 points
5th 11 points	10th 6 points	15th 1 point

Should a Tie occur it is to be resolved in accordance with TSR23 (a)

A rider who scores points in one Championship class shall not be eligible for points in another Championship class.

12 **Protests.** Protests in this Championship must be submitted within 30 minutes of the announcement of results provided the results are displayed within 30 minutes of the last rider finishing.

13 **Final Assessment.** At the conclusion of the Series, the points for each rider's performance in all rounds held less one will be added together and the rider with the highest number of points to his credit will be awarded the relevant Championship title. Should a tie occur it is to be resolved in accordance with TSR23 (b)

14 **Course.** The course shall be between 6 and 30 miles, with a minimum of 36 subsections. No more than 2 laps to achieve minimum mileage. There must be a minimum of 30 different subsections and no more than 10 double sub sections used.

15 **Observed Sections.** The sections should be of a natural terrain i.e. no man-made artificial hazards. Sections for the Intermediate Class will be determined by the Clerk of the Course and identified accordingly.

16 **Awards.** The Organisers shall supply a minimum of one award to the first eligible finisher in each class in the event. The overall winners of the series will receive a perpetual award which will be presented together with an ACU medal at the annual ACU Awards Presentation. Where more than one passenger accompanies the driver in the series the passenger named on the award shall be the one who rides in the most rounds.

17 **Jurisdiction.** IN GRANTING A PERMIT TO "PROMOTE" THE TRIALS AND ENDURO COMMITTEE DOES NOT ABROGATE ITS OVERALL RESPONSIBILITY FOR THE CHAMPIONSHIP SERIES AND MAY IN ITS ABSOLUTE DISCRETION, WITHHOLD POINTS FOR ALL OR PART OF A "ROUND" INTRODUCING A REPLACEMENT EVENT AT A LATER DATE IF SEEN FIT.

ACU S3 Parts National Trials Championship

These Championship Regulations to apply in addition to the National Sporting Code, Standing Regulations for Trials and the Supplementary Regulations for each event.

Championship points will be awarded to competitors of any Nationality. The title “ACU S3 Parts National Trials Champion” will be awarded to the competitor with the most points who holds British Citizenship. If the competitor with the most points is not a British Citizen, they will be awarded the title “ACU S3 Parts National Open Trials Champion”. This principle will apply throughout the Championship classes.

- 1 **Title of Event.** All Supplementary Regulations and Programmes must include the words – “incorporating the ACU S3 Parts National Trial Championship”. Where possible the sponsors logo provided must be used.
- 2 **Series Sponsor.** Where there is a Series Sponsor who provides bibs/riding numbers, these must be used by the rider without alteration or the obscuring of Sponsors’ logo
- 3 **Eligibility.** Any entry once accepted by the organiser renders the rider eligible for awards and Championship points. To be eligible for Championship points, (Classes A, B and C) the riders must not, in the previous three calendar years, have
 - Finished in the top ten places in the final standings of the British Solo Trials Championship in the previous three calendar years.
 - Won the British Solo Expert Class of the British Solo Trials Championship in the previous three calendar years.
 - Won the S3 Parts ACU National Trials Championship more than once in the previous three years.
 Exceptions may be made at the discretion of the Trials and Enduro Committee.
 PRIORITY OF ENTRY AT THE CLOSING DATE IS TO BE GIVEN TO RIDERS IN THE S3 PARTS CHAMPIONSHIP CLASSES
- 4 **Classes.**
 - A. All riders eligible for Championship points.
 - B. Riders eligible for Championship points who are aged over 40 years at the date of the competition are also eligible for points in the “Over 40 S3 Parts Championship”.
 - C. Riders eligible for Championship points and riding a machine not exceeding 125cc are also eligible for points in the “125cc S3 Parts Championship”.
 - D. Additional riders not eligible for Championship points (as described above) who wish to ride the Championship route through the sections. Organisers may include a 3rd route of up to 10 sections of higher severity for this class.
 - E. Optional Non Championship class
Organisers may have an additional easier route on up to 50% of the sections for a non championship class.
- 5 **Sections.**
Riders riding Classes A, B, C, and D will ride the principle route through all sections. Riders riding Class E (if included at the organiser’s discretion) will ride no less than 50 % of the principle Sections and an easier marked route through the remainder.
- 6 **Starting Intervals.** All riders must start individually at One Minute Intervals. All Championship route riders must start consecutively, and must not be segregated by group.
- 7 **Time.** If a time restraint is applied to part of or all of the Trial, it shall be in the form of

an individual Time Allowance for each rider and the details given in the Supplementary Regulations or Final Instructions.

- 8 **Championship Points.** Championship points for each class will be awarded to the top 15 eligible finishers in each round on the following scale:

1st 20 points	6th 10 points	11th 5 points
2nd 17 points	7th 9 points	12th 4 points
3rd 15 points	8th 8 points	13th 3 points
4th 13 points	9th 7 points	14th 2 points
5th 11 points	10th 6 points	15th 1 point

Should a Tie occur it is to be resolved in accordance with TSR23 (a)

- 9 **Final Assessment.** At the conclusion of the Series, the points for each rider's best results from all rounds held less one, will be added together and the rider with the highest number of points to his credit will be awarded the relevant Championship title.
Should a tie occur it is to be resolved in accordance with TSR23 (b)

- 10 **Awards.** The organisers shall supply a minimum of three awards to the first three eligible finishers in the event, plus an award for the best 125cc award winner and an award for the best over 40 years award winner. The overall winner of the Series will receive a perpetual award which will be presented, together with an ACU gold medal, at the annual ACU Awards Presentation.

- 11 **Special Notes.** Entry Form/Programme. Provision must be made for the declaration of eligibility for this Championship on the entry form and the programme must indicate which riders are eligible to compete.

- 12 **Protests.** Protests in this Championship must be submitted within 30 minutes of the announcement of results provided the results are displayed within 30 minutes of the last rider finishing.

- 13 **Course.** Whilst this is a National Trial, the Championship course must be laid out to a standard suitable for Clubman type. The course shall be between 6 and 30 miles, with a minimum of 36 subsections. No more than 2 laps to achieve minimum mileage. There must be a minimum of 30 different subsections and no more than 10 double sub sections used

- 14 **Method of Marking.** The Championship will be held under TSR22B.

- 15 **Jurisdiction.** IN GRANTING A PERMIT TO "PROMOTE" THE COMMITTEE DOES NOT ABROGATE ITS OVERALL RESPONSIBILITY FOR THE CHAMPIONSHIP SERIES AND MAY IN ITS ABSOLUTE DISCRETION, WITHHOLD POINTS FOR ALL OR PART OF A "ROUND" INTRODUCING A REPLACEMENT EVENT AT A LATER DATE IF SEEN FIT.

ACU Normandale Traditional Trials Championship

These Championship Regulations to apply in addition to the National Sporting Code, Standing Regulations for Trials and the Supplementary Regulations for each event.

Championship points will be awarded to competitors of any Nationality. The title “ACU Normandale Traditional Trials Champion” will be awarded to the competitor with the most points who holds British Citizenship. If a competitor with the most points is not a British Citizen they will be awarded the title “ACU Open Traditional Trials Champion”. This principle will apply throughout the Championship classes.

- 1 **Title of Event.** All Supplementary Regulations and Programmes must include the words “A round of the ACU Normandale Traditional Trials Series” in the heading and reference to the sponsor, if any, is to be made at the beginning of the regulations.
- 2 **Series Sponsor.** Where there is a Series Sponsor who provides bibs/riding numbers, these must be used by the rider without alteration or the obscuring of Sponsors’ logo
- 3 **Qualifying Meetings.** The list of events may be found in the current ACU Fixture List.
- 4 **Eligibility.** Priority of entry at the closing date will be given to Championship points scorers from the current series and the previous year subject to completed entry forms being received by that date. Any entry once accepted by the organiser renders the rider eligible for awards and Championship points.
- 5 **Classes**
 CLASS A – All major machine components including frame, forks, hubs, engines and gearboxes, to be a silhouette of the original British manufactured parts which were available before 1975.
 CLASS B – Machines with Twinshock rear suspension as fitted at the time of manufacture and fitted with drum brakes
 CLASS C – Air cooled engines not eligible for class A or B.
 CLASS D – Riders over 50 years of age at the date of the competition – on any Machine not eligible for classes A, B or C.
 CLASS E – Riders over 60 years of age at the date of the competition – on any Machine not eligible for classes A, B or C.
 Modified Route (up to 50% Harder Sections)
 CLASS F – Riders over 40 years of age at the date of the competition on any Machine. Competitors can only enter ONE Class.
 All riders in the same class must ride the same route.
 An additional Non-Championship class may be added at the organisers discretion.
 However priority must be given to Championship entrants if the number of entries is limited.
- 6 **Course** The course shall be of a simple loop type, of no more than 2 laps with a total overall distance of between 15 and 30 miles.
- 7 **Observed Sections** Sections. The sections shall be of natural terrain, i.e. no man made materials shall be used, and should be suitable for all classes.
- 8 **Marking.** Marking will be to TSR22 B No stop permitted.
- 9 **Starting Intervals.** All riders must start at one minute intervals. All Championship class riders must start consecutively.
- 10 **Time.** If a time restraint is applied to part of or all of the Trial, it shall be in the form of

an individual Time Allowance for each rider and the details given in the Supplementary Regulations or Final Instructions.

11 **Championship Points.** Championship points will be awarded to the top 15 eligible finishers in each class at each round on the following scale:

1st 20 points	6th 10 points	11th 5 points
2nd 17 points	7th 9 points	12th 4 points
3rd 15 points	8th 8 points	13th 3 points
4th 13 points	9th 7 points	14th 2 points
5th 11 points	10th 6 points	15th 1 point

Should a Tie occur it is to be resolved in accordance with TSR23 (a)

Riders who score points in one championship class shall not be eligible for points in another championship class

12 **Final Assessment.** At the conclusion of the Series, the points for each rider’s best results from all rounds held less one will be added together and the rider with the highest number of points to his credit will be awarded the relevant Championship title.

Should a tie occur it is to be resolved in accordance with TSR23 (b)

13 **Protests.** Protests in this Championship must be submitted within 30 minutes of the announcement of results, provided the results are displayed within 30 minutes of the last rider finishing.

14 **Awards.** The organisers shall supply a minimum of one award to the first eligible finisher in each class in the event. The overall winner of the Series will receive a perpetual award which will be presented, together with an ACU medal, at the annual ACU Awards Presentation.

15 **Jurisdiction.** IN GRANTING A PERMIT TO “PROMOTE” THE COMMITTEE DOES NOT ABROGATE ITS OVERALL RESPONSIBILITY FOR THE CHAMPIONSHIP SERIES AND MAY IN ITS ABSOLUTE DISCRETION, WITHHOLD POINTS FOR ALL OR PART OF A “ROUND” INTRODUCING A REPLACEMENT EVENT AT A LATER DATE IF SEEN FIT.

ACU Sammy Miller Trial Championship

These Championship Regulations to apply in addition to the National Sporting Code Standing Relegations for Trials and the Supplementary Regulations for each event.

Championship points will be awarded to competitors of any Nationality. The title “ACU Sammy Miller Trials Champion” will be awarded to the competitor with the most points who holds British Citizenship. If the competitor with the most points is not a British Citizen they will be awarded the title “ACU Open Sammy Miller Trials Champion”. This principle will apply throughout the Championship classes.

- 1 **Title of Event.** All Supplementary Regulations and Programmes must include the words “A Round of The Sammy Miller British Trials Bike Championship”.
- 2 **Qualifying Meetings.** The list of events may be found in the current ACU Fixture List.
- 3 **Eligibility:** Open to all riders of machines in the following classes
 CLASS 1 – Pre-Unit Rigid – Pre 65
 CLASS 2 British Pre 70 Pre-Unit/Unit/2Stroke (Twinshocks)
 CLASS 3 – Machines with twinshock rear suspension and drum brakes as at the time of manufacture which are not eligible for class 2
 CLASS 4 – Sidecar machines eligible for classes 1, 2 and 3
All the above to be run on the route B.
 CLASS 5 – British Pre 70 Pre-Unit/Unit/2 Stroke (Twinshocks)
 CLASS 6 – Machines with twinshock rear suspension and drum brakes as at the time of manufacture which are not eligible for class 5
The above classes to be run on the route A.
 Classes 1, 2 & 5 must have British Engine, Carburettor, Forks (Max 35mm) and hubs. All classes must have Original or Replica Frames of which at least 50 have been made.
 An additional Non-Championship class for Air-cooled Monos and Trail bikes may be added at the organisers discretion. However priority must be given to Championship entrants if the number of entries is limited.
- 4 **Course.** The course should be between 30 and 50 miles in length and include 25 to 35 sub-sections suited to the type of machine and rider entered. It is recommended that steep drops and tight turns are avoided. Alternative easier route sections should be used for classes 1, 2, 3 & 4. Suitable off-road events of a shorter length may be allowed at the discretion of the Trials and Enduro Committee.
- 5 **Method of Marking.** As per TSR22B Non-Stop.
- 6 **Starting Intervals.** All riders must start at one minute intervals, by class.
- 7 **Time.** If a time restraint is applied to part of or all of the Trial, it shall be in the form of an individual Time Allowance for each rider and the details given in the Supplementary Regulations or Final Instructions
- 8 **Championship Points.** Any entry once accepted by the organiser renders the rider eligible for awards and Championship points. Championship points will be awarded to the top 15 eligible finishers in each class at each round on the following scale:

1st 20 points	6th 10 points	11th 5 points
2nd 17 points	7th 9 points	12th 4 points
3rd 15 points	8th 8 points	13th 3 points
4th 13 points	9th 7 points	14th 2 points
5th 11 points	10th 6 points	15th 1 point

- Should a Tie occur it is to be resolved in accordance with TSR23 (a)
- 9 **Final Assessment.** At the conclusion of the Series, the points for each rider's results from all rounds held less one will be added together and the rider with the highest number of points to his credit will be awarded the relevant Championship title.
- Should a tie occur it is to be resolved in accordance with TSR23 (b)
- 10 **Special Award.** At the end of the series a special Sammy Miller Trophy will be awarded for the rider with the best overall performance, who loses the least amount of marks, and has competed in all rounds on the top course on a British Bike.
- 11 **Protests.** Protests in this Championship must be submitted within 30 minutes of the announcement of results, provided the results are displayed within 30 minutes of the last rider finishing.
- 12 **Jurisdiction.** IN GRANTING A PERMIT TO "PROMOTE" THE COMMITTEE DOES NOT ABROGATE ITS OVERALL RESPONSIBILITY FOR THE CHAMPIONSHIP SERIES AND MAY IN ITS ABSOLUTE DISCRETION, WITHHOLD POINTS FOR ALL OR PART OF A "ROUND" INTRODUCING A REPLACEMENT EVENT AT A LATER DATE IF SEEN FIT.

ACU OSET British Solo Youth Trials Championship

These Championship Regulations to apply in addition to the National Sporting Code, Standing Regulations for Trials and the Supplementary Regulations for each event.

Championship points will be awarded to competitors of any Nationality. The title “ACU OSET British Solo Youth Trials Champion” will be awarded to the competitor with the most points who holds British Citizenship. If the competitor with the most points is not a British Citizen they will be awarded the title “ACU OSET British Open Solo Youth Trials Champion”. This principle will apply throughout the Championship classes.

- 1 **Title of Event** All Supplementary Regulations and Programmes must include the words “A Round of The ACU OSET British Solo Youth Trials Championship”
- 2 **Series Sponsor.** Where there is a Series Sponsor who provides bibs/riding numbers, these must be used by the rider without alteration or the obscuring of Sponsors’ logo.
- 3 **Eligibility.** Open to B, C & D Class youth riders as defined under TSR1.
- 4 **Classes.** See TSR 1.
- 5 **Routes**
 B Class will ride Route 1
 C Class Standard wheel will ride Route 2
 C Class Medium wheel will ride 50% Route 2 – 50% Route 3
 D Class Medium wheel will ride Route 3
 D Class Small wheel will ride Route 4
 Any rider wishing to ride in a class lower than their age may do so on a no points basis
- 6 **Starting Order.** The riders will have their starting order determined by ballot.
- 7 **Starting Intervals.** All riders will start at one minute intervals, by class
- 8 **Cut Out Device.** All competitors riding combustion engine machines must have cut out devices rigidly connected to the rider by lanyard (max length 1 metre) so as to stop the engine should the rider and machine be parted.
- 9 **Time Allowed.** There will be an overall individual time allowance for the Trial. The Final Time Control must be located immediately after the final section. The rider is obliged to go directly from the Final Control to the Results Recorder. Any rider who delays the publication of a result will be reported to the Stewards of the Meeting for disciplinary action.
- 10 **Assistants** At the discretion of the organisers, riders in Classes C & D only may register one assistant to accompany them on the course and carry tools, provided he is not riding a machine. The assistant must be a minimum age of 18 years. The rider and the assistant must sign a declaration that the rider is responsible for all the actions of the assistant. The assistant will only be allowed into the boundaries of a section if their rider is in that section and if specifically invited by an official. The Assistant must wear identification supplied by the organiser. In the case of an injury, a substitute assistant may be registered. The rider may receive assistance to repair their machine anywhere on the course. The rider’s machine must travel the whole distance of the course under its own power or the exertion of the rider.

- 11 **Championship Points** Any entry once accepted by the organiser renders the rider eligible for awards and Championship points. Championship points will be awarded to the top 15 eligible finishers in each class at each round on the following scale: A rider can only gain Championship points from one class in one year.
- | | | |
|---------------|---------------|---------------|
| 1st 20 points | 6th 10 points | 11th 5 points |
| 2nd 17 points | 7th 9 points | 12th 4 points |
| 3rd 15 points | 8th 8 points | 13th 3 points |
| 4th 13 points | 9th 7 points | 14th 2 points |
| 5th 11 points | 10th 6 points | 15th 1 point |
- Should a Tie occur it is to be resolved in accordance with TSR23 (a)
Riders who score points in one championship class shall not be eligible for points in another championship class.
- 12 **Protests.** Protests in this Championship must be submitted within 30 minutes of the announcement of results, provided the results are displayed within 30 minutes of the last rider finishing.
- 13 **Final Assessment.** At the conclusion of the series, the points for each rider's performance from all rounds held less one will be added together and the rider with the highest number of points to his credit will be the winner.
Should a tie occur it is to be resolved in accordance with TSR23 (b)
- 14 **Observed Sections.** Each observed section or subsection must be attempted in the order in which they are numbered, except where a class is instructed to start other than at Section 1, they must still attempt the sections consecutively. The sections should be of natural terrain, i.e. no man-made hazards and consecutively numbered.
- 15 **Method of Marking.** As per TSR 22B.
- 16 **Assistance on the Course** The rider may receive assistance to repair their machine anywhere on the course. The rider's machine must travel the whole distance of the course under its own power or the exertion of the rider.
- 17 **Course.** The number of laps and approximate length of lap must be stated in the Supplementary Regulations.
- 18 **Riding Bibs.** If bibs are supplied they must be worn by competitors throughout the event without any defacement.
- 19 **Jurisdiction.** IN GRANTING A PERMIT TO 'PROMOTE' THE COMMITTEE DOES NOT ABROGATE ITS OVERALL RESPONSIBILITY FOR THE CHAMPIONSHIP SERIES AND MAY IN ITS ABSOLUTE DISCRETION, WITHHOLD POINTS FOR ALL OR PART OF A 'ROUND' INTRODUCING A REPLACEMENT EVENT AT A LATER DATE IF SEEN FIT.

ACU British Ladies and Girls Trials Championships

These Championship Regulations to apply in addition to the National Sporting Code, Standing Regulations for Trials and the Supplementary Regulations for each event.

Championship points will be awarded to competitors of any Nationality. The title “ACU British Ladies and Girls Trials Championships” will be awarded to the competitor with the most points who holds British Citizenship. If the competitor with the most points is not a British Citizen they will be awarded the title “British Ladies/Girls Open Trials Champion”. This principle will apply throughout the Championship classes.

- 1 **Title of Event.** All Supplementary Regulations and Programmes must include the words – “incorporating the ACU British Ladies And Girls Trials Championships”.
- 2 **Series Sponsor.** Where there is a Series Sponsor and the Organiser provides bibs/riding numbers, these must be used by the rider without alteration or the obscuring of Sponsors’ logo.
- 3 **Eligibility.** All riders in the Championship classes must be of the female gender. Classes for girls are as defined under youth riders in TSR1.
- 4 **Classes**
 Ladies Championship
 Girls A Championship
 Ladies Intermediate Championship
 Girls A Intermediate Championship
 Girls B Championship
 Girls C Championship
 Ladies Sportsperson (Non Championship)
 Girls Sportsperson (Non Championship)
 At the end of the Series an award will be presented to winners of each of the above Championship Classes.
 An additional supplementary class of either Adult Novices, Twinshocks, Pre-65, Sidecar, or Youth may be included. This additional class to be limited to a maximum of 25 riders of either sex.
- 5 **Starting.** Starting intervals shall be at intervals of 1 minute.
- 6 **Cut Out Device.** All competitors riding combustion engine machines must have cut out devices rigidly connected to the rider by lanyard (max length 1 metre) so as to stop the engine should the rider and machine be parted.
- 7 **Time Allowed.** There will be an overall individual time allowance for the Trial. The Final Time Control must be located immediately after the final section. The rider is obliged to go directly from the Final Control to the Results Recorder. Any rider who delays the publication of a result will be reported to the Stewards of the Meeting for disciplinary action.
- 8 **Method of Marking.** The Championship will be held under TSR 22B.

9 **Course.** The course will be entirely on private land and will consist of a minimum of ten sections.

There will be 3 routes as follows:

- | | |
|-----------------------------|--|
| ROUTE 1 | Ladies Championship Class |
| 50% ROUTE 1 and 50% ROUTE 2 | Girls A Championship Class |
| ROUTE 2 | Ladies Intermediate Championship Class |
| | Girls A Intermediate Championship Class, |
| | Girls B Championship Class |
| ROUTE 3 | Girls C Championship Class, |
| | Ladies Sportsperson (Non Championship) |
| | Girls Sportsperson (Non Championship) |

All routes to be clearly distinguished with appropriate marking.

10 **Assistants.** At the discretion of the organisers, riders in Class C only may register one assistant to accompany them on the course and carry tools, provided he is not riding a machine. The assistant must be a minimum age of 18 years. The rider and the assistant must sign a declaration that the rider is responsible for all the actions of the assistant. The assistant will only be allowed into the boundaries of a section if their rider is in that section and if specifically invited by an official. The Assistant must wear identification supplied by the organiser. In the case of an injury, a substitute assistant may be registered. The rider may receive assistance to repair their machine anywhere on the course. The rider's machine must travel the whole distance of the course under its own power or the exertion of the rider.

11 **Championship Points.** Any entry once accepted by the organiser renders the rider eligible for awards and Championship points. Championship points will be awarded to the top 15 eligible riders in each Championship Class at each event on the following scale for each class:

1st 20 points	6th 10 points	11th 5 points
2nd 17 points	7th 9 points	12th 4 points
3rd 15 points	8th 8 points	13th 3 points
4th 13 points	9th 7 points	14th 2 points
5th 11 points	10th 6 points	15th 1 point

Should a Tie occur it is to be resolved in accordance with TSR23 (a)

A rider who scores points in one Championship class shall not be eligible for points in another Championship class

12 **Protests.** Protests in this Championship must be submitted within 30 minutes of the announcement of results provided the results are displayed within 30 minutes of the last rider finishing.

13 **Final Assessment.** At the conclusion of the series, the points for each rider's performance from all rounds held less one will be added together and the rider with the highest number of points to his credit will be awarded the relevant Championship title.

Should a tie occur it is to be resolved in accordance with TSR23 (b)

14 **Jurisdiction.** IN GRANTING A PERMIT TO 'PROMOTE' THE COMMITTEE DOES NOT ABGOGATE ITS OVERALL RESPONSIBILITY FOR THE CHAMPIONSHIP SERIES AND MAY IN ITS ABSOLUTE DISCRETION, WITHHOLD POINTS FOR ALL OR PART OF A 'ROUND' INTRODUCING A REPLACEMENT EVENT AT A LATER DATE IF SEEN FIT.

ACU Trail Bike Series incorporating the ACU Trail Bike Championship

The ACU will promote a Trail Bike Series which is aimed at riders who want an enjoyable day on and off road on their road legal machine with Observed Sections suitable for such machines.

Championship points will be awarded to competitors of any Nationality. The title “ACU Trail Bike Champion” will be awarded to the competitor with the most points who holds British Citizenship. If the competitor with the most number of points is not a British Citizen they will be awarded the title “ACU Open Trail Bike Champion”.

1 **Title Of Event.** All Supplementary Regulations and programmes must include the words “A round of the ACU Trail Bike Championship” and the name of any official series sponsor.

2 **Qualifying Meetings.** The list of events may be found in the current ACU Fixture List.

3 **Eligibility.** Trail Bike Series Open to machines that are fully legal to use the Public Highway fitted with working lights, Trials Spec Tyres as per TSR8 and be silenced to comply with TSR 14.

Trail Bike Championship. Open to machines that comply with the following in addition to the above:

1. Wheelbase not less than 1350mm
2. Minimum 5 litre fuel tank
3. Minimum seat length 350mm

Converted Trial Bikes will be excluded from this Class. The organiser, in conjunction with the Trials & Enduro Committee, reserves the right to place machines regarded as ineligible in the appropriate Class, and the rider will therefore not qualify for Championship points.

4 **Course.** It is recommended that the course should be between 25 and 75 miles in length and include 25 to 40 sub-sections suited to the type of machine and rider entered. It is recommended that tight turns and steep drops be avoided. Organisers have the option to offer a dual route on a maximum of 6 sections. The harder route would cater for the Championship Class and the easier route for all other classes, with the dual routes being clearly marked. A rider shall be given the opportunity to inspect a section before riding it.

5 **Method of Marking.** As per TSR22 B Non Stop.

6 **Championship Points.** Any entry once accepted by the organiser renders the rider eligible for awards and Championship points.. Championship points will be awarded to the top 15 eligible finishers at each round on the following scale:

1st 20 points	6th 10 points	11th 5 points
2nd 17 points	7th 9 points	12th 4 points
3rd 15 points	8th 8 points	13th 3 points
4th 13 points	9th 7 points	14th 2 points
5th 11 points	10th 6 points	15th 1 point

Should a Tie occur it is to be resolved in accordance with TSR23 (a)

7 **Final Assessment.** At the conclusion of the Series, the points for each rider’s results from all rounds held less one, will be added together and the rider with the highest number of points to his credit will be awarded the relevant Championship title.
Should a tie occur it is to be resolved in accordance with TSR23(b)

8 **Protests.** In this Championship must be submitted within 30 minutes of the announcement of results provided the results are displayed within 30 minutes of the last rider finishing.

9 **Awards.** The organisers shall supply a minimum of one award to the first eligible finisher in

- each class in the event. The overall winner of the Series will receive a perpetual award, which will be presented, together with an ACU medal, at the annual ACU Awards Presentation.
- 10 **Jurisdiction.** IN GRANTING A PERMIT TO “PROMOTE” THE COMMITTEE DOES NOT ABROGATE IT’S OVERALL RESPONSIBILITY FOR THE CHAMPIONSHIP SERIES AND MAY, AT ITS ABSOLUTE DISCRETION, WITHHOLD POINTS FOR ALL OR PART OF A “ROUND” INTRODUCING A REPLACEMENT EVENT AT A LATER DATE IF SEEN FIT.

TRIALS – MACHINE EXAMINER’S CHECK LIST

GENERAL TRIALS

Machines should be in general good condition with no obvious parts missing or not working. Should be adequately silenced and the following checked:

- Brake and Clutch levers should have ball ended levers
- Folding Footrests
- Self closing throttle
- Have trials tyres
- Have a helmet and suitable boots

For **youth competitors** the additional items should be checked:

- Operation of cut out device
- Correct engine and wheel size size for age of rider
- Have gloves and the forearms covered

And **sidecars** should have:

- A nose cone
- Seat for the passenger
- Passenger has helmet and suitable boots

For entries into special ACU championships the following should be checked:

TRADITIONAL CHAMPIONSHIP

Class A – All major components including frame, forks, hubs, engines and gear boxes to be a silhouette of the original British manufactured parts, which were available before the date of eligibility for the class concerned.

Class B – Have two rear shocks (as at time of manufacture) and drum brakes

Class C – Have one rear shock and air cooled engine

SAMMY MILLER CHAMPIONSHIP

Classes 1, 2, 5, – Major parts should be a silhouette of original British manufactured parts available prior to the date of eligibility for the class concerned.

Classes 3 & 6 – Must have Twinshock rear suspension as fitted at the time of manufacture and be fitted with drum brakes.

TRIALS OFFICIALS

QUALIFICATIONS AND CONDITIONS

Officials are divided into two categories: Those that are Licensed and those that are Registered. No Fees are payable in respect of any Licences or Registration or for the appropriate form of identification issued.

LICENCES: Senior Officials are required to hold an ACU Licence of the appropriate Grade for the performance of their duties.

	See Note Below	Licence Required	Attendance at Seminar/ Training Session
Clerk of the Course	1	YES	3 YEARS Every Third Year maximum
Chief Steward	2	YES	3 YEARS Every Third Year maximum
Secretary of the Meeting	2	No	Will receive Training at meetings and if required at Regional or ACU HQ Seminars
Club Stewards		No	May attend Regional or ACU HQ Seminars

Clubs and Centres shall only nominate candidates whose aptitude and integrity for the position they can fully justify. Official ACU approval and the issue of a Licence is only after the candidates have proved to be competent according to the special requirements for each discipline. The respective Committees and Panels organise Seminars that are compulsory for certain Officials. A Licence is valid for 3 years.

Note 1 Clerk of the Course

GRADES

Regional must attend a seminar organised by a Centre/Region.

National must attend a National seminar organised by the Trials & Enduro Committee and must also comply with specific criteria.

Note 2 Steward

GRADES

Regional will be appointed by the Centre as the Permit issuing authority as required.

National will be appointed by the Trials & Enduro Committee as the Permit issuing authority and must also comply with specific criteria.

LICENCE FEES All licences will be issued, free of charge, for a period of three years.

Arena Trials

The National Sporting Code of the ACU and these Standing Regulations shall apply to all Arena Trials together with the Supplementary Regulations and any Final instructions issued for individual events.

1 GENERAL

- 1.1 **Description.** An Arena Trial is a test of riding skill and balance over a variety of observed obstacles with riders incurring penalties for footing or for failing to fulfil other conditions. The obstacles (Sections) are usually man made, specifically for the event which is held within an arena or stadium. The Standing Regulations for Trials (TSR's) as printed in this Handbook shall be applicable with the following amendments.
- TSR3** Entries shall be by the invitation of the organising Club.
- TSR20** The order in which the Sections shall be attempted must be explained to the riders at the briefing meeting.
- TSR21** Any obstacle which is more than 1000mm from the ground and has a width of less than 500mm shall have a firm support below and along the full length of the said obstacle. The "Start" and "End" of each Section shall be clearly marked and the lateral limits clearly explained at the briefing meeting.
- TSR22** The method of marking shall be to TSR22A
- TSR28** Prior to the start of the above event the Clerk of the Course must hold a briefing meeting which must be attended by all riders, the Referee and the Observer(s). The Clerk of the Course must inform the riders of the lateral limits of each Section, the order that they will be attempted in and any other information for the smooth running of the event.
- TSR33** A person holding a certificate of First Aid competency must be present throughout the duration of the event. The organiser shall be conversant with the nearest Accident/Emergency services and have the means of contacting them.
- TSR41** It is not permitted to hold an Arena Trials on a Time and Observation basis.

Additionally the following apply

- 1 **Referee.** A Referee shall be appointed by the body issuing the permit who must carry out a course inspection prior to the start. The Referee shall replace the Stewards of the Meeting and have the same powers and obligations.
- Duties of the Referee**
- He shall be in attendance throughout the meeting and for such further period of time as be necessary for him to complete his duties arising therefrom.
 - He shall have the duty of enforcing these Regulations.
 - He shall prohibit from competing a rider whom, or a motorcycle which, he considers might be a source of danger.
 - He shall immediately deal with any appeal that may properly be delivered to him during a meeting.
- 2 **Permit.** A permit may be issued by a Local Centre for events of up to Centre Restricted, which must comply with the following restrictions:
- The event is not televised other than for local promotional reasons where the transmission must not exceed 5 minutes.
 - No Audience participation.
 - No involvement of "Fire" in the display,
 - No free-style jumping or jumping competition.
 - Only controlled riding over obstacles NOT jumping over vehicles or people.
 - Estimated audience not to exceed 1,000.

- g) Any “Contractual Terms” must exclude any liability upon the organiser for slipping or tripping in public areas or in Grandstands or in Car Parks.
In all other cases the Permit must be issued by the ACU Office.
- 3 **Spectator safety.** Where no wooden paling or interlinked metal public fence is provided double roping must be erected. The inner rope must be a minimum of 7m from the obstacles and the outer rope must be a distance of 4m from the inner rope.

ATV Trials

The ACU Standing Regulations for Trials shall apply to all events catering for Quads and/or Trikes with the following Regulations amended as shown.

- 8 **MACHINES.** Machines must apply to Appendix B of the National Sporting Code. Prior to the start of each Trial all machines will be examined to ensure that they comply with ACU Specifications.
 The Supplementary Regulations for each event shall indicate the Categories and Groups of machines eligible. Soundly constructed mudguards must be fitted to prevent the rider’s foot being caught under a wheel.
- 9 **TYRES.** Any production tyres may be used. The treads of the tyre must not be cut or altered in any way. The fitting of chains or other non-skid attachments is prohibited.
- 21 **OBSERVED SECTIONS.** The lateral limits of an Observed Section may be defined by artificial boundaries such as markers or tapes, which shall be firmly placed and positioned in a way so as to clearly define the intended limits of the section. If markers are to be used they shall be of different colours for left and right. If tapes are to be used they shall be of height at least 300mm from the ground. The Start and Finish of each Observed Section will be clearly defined, with the Section Begins and Section Ends identified as such.
 Sections shall be numbered or lettered and ridden in the correct sequence.
 Numbered boards will be placed at intervals along sections to enable each driver’s performance to be determined (numbered from 4–1).
- 22 **METHOD OF MARKING.** A machine will be deemed to be in an Observed Section when the front wheel spindle(s) has passed the “Section Begins” card and until the front spindle(s) has passed the “Section Ends” card.
 Marks will be lost in a decreasing manner from 5 to 0 depending on the distance a rider can traverse the section without loss of marks. The front wheel spindle(s) is the part of the machine to be used for assessing the distance traversed.
- 0 Clean
 - 1 Reaching or passing the “1 Board” without loss of marks.
 - 2 Reaching or passing the “2 Board” without loss of marks.
 - 3 Reaching or passing the “3 Board” without loss of marks.
 - 4 Reaching or passing the “4 Board” without loss of marks.
 - 5 Failure to reach the “4 Board”.
 - 10 Not attempting a section when called upon to do so by an Official (in addition to any marks subsequently lost in that section).

DEFINITIONS

Clean A rider traversing an Observed Section without loss of marks as described below.

Loss of Marks The number of marks lost will be defined by the distance traversed when any of the following occur:

- a) The machine ceases to move in a forward direction.
- b) The rider dismounts from the machine.

- c) The rider foots i.e. if any part of his body touches the ground, or benefit is gained from any part of his body leaning on an obstacle (tree, wall etc.).
- d) A machine does not stay within the intended limits of the section and within each marker.
- e) If any wheel of the machine crosses any boundary tape or marker whether the wheel be on the ground or airborne before the front wheel spindle(s) passes the "Section Ends" sign.
- f) The rider is held responsible for breaking and/or removing a marker or support in an observed section before the front wheel spindle(s) passes the "Section Ends" sign.
- g) Travelling in a forward direction against the direction of the section.
- h) The machine or rider receives outside assistance.
- i) The engine of the machine ceases to operate.

Bicycle Trials

The National Sporting Code of the ACU and these Standing Regulations shall apply to all events organised under the jurisdiction of the ACU with the Supplementary Regulations and any Final Instructions issued for individual events.

DEFINITION

Bicycle Trial is an individual sport that may incorporate the use of a special bike which the rider must manoeuvre and balance in order to ride through specially designed artificial or natural "sections". The objective is to pass through the sections in minimum time and with as little physical contact with the ground as possible, hence obtaining minimum penalty points.

1 ORGANISING PERMITS

For National events and above organised by a Centre Affiliated Club and all events organised by a Non-Territorial Club Permit Application forms are available from, and the completed form should be returned to the Trials & Enduro Secretary, ACU House, Wood Street, Rugby, Warwickshire CV21 2YX. For events of below National status you should contact your local Centre Permit Secretary as in the front of the Handbook.

The completed Permit application form shall be accompanied by the following:

- A copy of the Supplementary Regulations for the event
- Permit Fee, if decided applicable by the Permit Issuing Authority

2 OFFICIALS

The names of the Clerk of the Course and their licence number must be stated in the Supplementary Regulations, together with the names and address of the Secretary of the Meeting and the names of any Stewards. The ACU Trials and Enduro Committee reserves the right to appoint a Steward to any event should they deem it necessary.

3 ENTRIES

Entry forms accompanied by the entry fee must be complete in every detail, signed by the rider and in the case of riders under 18 years of age, the parent or guardian or responsible adult and forwarded to the Secretary of the Meeting by the stated closing date. The rider's current ACU Registration Number must be stated.

Riders under 18 years of age (Minors): In order to conform to the Children's Act legislation, additionally for every rider who is under 18 years of age, a parental agreement must be signed. This is incorporated in the annual Competition Licence and Trials Registration form and once completed will serve as the rider's Annual Parental Agreement. No further forms of proof of Parental Agreement are necessary. All minors will be bound by the directions of parents(s), guardian(s) or other appointed adult responsible for them at any event. (Please see licence application form for further details).

The point of contact for Child Protection issues will be the Secretary of the Meeting unless otherwise stated in the Supplementary Regulations.

4 MEDICAL SERVICES

It is recommended that a person holding a certificate of First Aid competency be present at all events. In addition it is recommended that the organiser shall be conversant with the nearest Accident/Emergency services and ensure that they have a means of contacting them. Organisers must also refer to the "Medical Services and Definition" section of this Handbook.

5 SECTIONS

- a) Each section must be clearly marked; with the section start and finish gates clear to allow queuing space and to avoid accidents.
- b) It is recommended where possible, that each section should be surrounded by strong boundary tape. The tape must be totally visible and well secured to stakes or other objects which must be fixed underground. The entirety of the tape must be fastened at a maximum height of 500mm. All broken tape must be replaced in the same position before another rider enters the section. Spare section marking tape should be provided at each section.
- c) The sections should be designed in a way that suits the different levels of ability in the different categories, with separate routes where necessary and which would not create any danger for both riders and spectators. The sections should differ substantially from each other and show variety. It is recommended that the same colour markers are used each side of the section to show the route, blue being the common route to be ridden unless there is a variation, white markers being used for an easier route, red for a harder route and yellow for a harder route in addition to the red route, for example, a yellow route rider will ride the blue route unless there is a red deviation or yellow deviation and the red route unless there is a yellow deviation.
- d) The Clerk of the Course should provide clear instructions of the locations of the sections for every rider before the competition.

6 CLERK OF THE COURSE

The Clerk of the Course will be in charge of all matters concerning the event; including organisation, structure, enrolment, start/arrival procedure, track, sections, results, observers etc. A Risk Assessment should be carried out for every event.

7 OBSERVER

An Observer is an assistant to the Clerk of the Course appointed to judge a competitors performance in an observed section. No protest or appeal can be accepted against the judgement of performance made by an Observer; however a protest may be accepted against any breach or misinterpretation of the Regulations. A mistake made by an Observer may be corrected by the Observer with the approval of the Clerk of the Course. The Observer will be provided with a 'count down' mechanism which will make an acoustic sound to signify the end time. Besides this, the Observer must advise the riders approximately one minute before the finishing time and at 30 seconds, 15 seconds, 5, 4, 3, 2, 1.

8 CATEGORIES & ROUTE/RIDER COLOURS

No rider may compete before his/her 6th birthday and riders who wish to compete in the 26inch wheel category should be 15 years old. Riders graded on ability and or age. Full details to be published in the Supplementary Regulations for each event.

9 BIKES

There should be separate classes for 20inch and 26inch wheeled machines. Bikes of any wheel sizes may be used at competitions at the discretion of the Organisers.

- a) Riders cannot change his/her bike during the event/competition
- b) Riders can change the broken parts except the frame of the bike.
- c) The end of the front and rear brake levers must not be finished in a dangerous form.
- d) The entirety of the bike must be provided with an effective brake system.
- e) Any overhanging metal of more than 10mm should be covered in order to avoid any dangerous situation.

Machine specifications may change according to the Supplementary Regulations, if machines need to be checked for eligibility this should be immediately before the start of the event.

10 SECTION PENALISATION

The method of penalisation must be clearly stated in the Supplementary Regulations.

11 TIME LIMIT

The finish time penalties will apply as soon as the rider exceeds his/her finishing time and 1 penalty point will apply for every 5 minutes over the individual's time limit. In the case of this exceeding 30 minutes, the rider will be disqualified.

12 BAULK

A baulk is deemed to have occurred when a rider, whilst attempting an observed section, is prevented from making a bona-fide attempt due to some outside obstruction. Should a rider claim a baulk, the Observer may at his/her discretion allow a rerun of the section. The Observer's decision as to whether a rerun is permitted is final. Should a rerun be granted, any marks lost prior to the point of the baulk on the original attempt shall stand and the section shall be observed from the point of the baulk.

13 ORGANISERS

The organiser must abide by these Standing Regulations and ensure that any Supplementary Regulations are issued to all riders.

14 PUNCH CARD

The card must be made of plastic or waterproof material labelled on the upper part of the card should be; the name of the rider, his/her number, the category and the colour group. On the lower part of the card should be space to write; the start time, finish time and overall time. The score will be indicated on the card by means of punching a hole in the position that corresponds with the number of penalty points. Where a mistake is made, all numbers should be punched out leaving only the correct score un-punched. Where a "10" has been given, all numbers should be punched including the section number. The reason should be noted on the reverse. The onus of looking after the penalisation card rests entirely with the rider. Any disagreement over the score punched, or errors, must be reported to the Secretary of the Meeting immediately upon completion of the event. The Observer must be informed that this action is being taken, as any errors not verified by the Observer shall not be accepted. Refusing to have the card punched, deliberately disfiguring the punch card will result in disqualification for which no protest will be accepted. In the case of a dispute between the Observer and the rider, the Observer will note it on the back of the penalisation card.

15 NUMBERS

The Organiser may provide "Numbers" for the riders and for their respective minders (one minder per rider, only the one minder may enter the section in a situation where the rider is in danger) the number size should be a maximum of 10 x 15cm for the bike as well as for the rider. Numbers should be placed at the head part of the bike so they are clearly displayed. The group colour should be clearly indicated.

16 THE RIDER

Riders are not allowed pre-competition practice inside the designated area of the course and sections. Any rider seen with his bicycle in any place (e.g. course and sections) within one week before the competition will be disqualified from the competition. Any attempt made to practice on the sections before the competition will result in the disqualification of the concerned rider from the event. On completion of the entry form, the rider is permitted to observe the sections on foot. The rider shall at all times behave in a sportsman-like manner throughout the event, refraining from any unfair action towards his fellow competitors, organiser or associates.

17 RIDER CLOTHING

If the rider does not abide with these attire regulations, he/she will be refused entry into the competition or sections. The rider must wear: when riding, the following; helmet, pants shirt and shoes. One-piece ankle protective footwear is recommended, but not compulsory. It is also recommended that shin guards, gloves, full length pants and shirts with long sleeves are worn. Advertisements on the rider's attire, helmet and bike are allowed. The advertising space on the numbers or bibs is reserved for the organisers. The rider cannot ride the event without the original bib (where provided) given from the organiser.

18 KNOWLEDGE OF THE RULES

The riders, upon applying for entry for competition must possess a thorough knowledge of these Rules and any Supplementary Regulations that may apply.

19 COMPETITION RESULTS

The placings will be determined by the total penalty points. The rider with the lowest points will be the winner of the competition, and so on. In the case of ties, the placing will be determined by the order as follows:

- a) The rider with more 0 points (clean)
- b) The rider with more 1 points
- c) The rider with more 2 points
- d) The rider with more 3 points
- e) The rider who completed the course in shorter time

20 PROTESTS

Only protests in writing will be accepted and attended to by the Organisers. Each Protest shall be from an individual rider and refer to a single subject. Each protest must be accompanied by a pre-determined payment of £50.00. Protests can only be addressed to the Clerk of the Course and no later than 30 minutes after the declaration of the results, provided the results are displayed within 30 minutes of the last rider finishing. If the Organisers fail to issue the results within this time frame, then the time limit for protests will be 14 days from their official publication.

21 CHAMPIONSHIP EVENTS

At each Championship event, the number of Championship points to be awarded to the top 15 in each category is as follows:

Place	Point	Place	Points	Place	Points
1st	20	6th	10	11th	5
2nd	17	7th	9	12th	4
3rd	15	8th	8	13th	3
4th	13	9th	7	14th	2
5th	11	10th	6	15th	1

The placing will be determined by the total Championship points at all events in that Championship.

The rider with the most points will be the Champion, and so on. In the case of ties, the placings will be determined by the order as follows:

- a) The rider with the most Championship points
- b) The rider with more 1st places, 2nd places, 3rd places, etc.
- c) The rider with the best result in the last competition in the case of a tie still existing.

22 AWARDS

Awards will be provided according to an event's Supplementary Regulations.

23 INSTRUCTIONS TO RIDERS

Any instruction to riders subsequently issued shall be in writing; either distributed individually for each rider or via a clearly situated notice board. Any instructions so issued shall have the same force as these Standing Regulations and the Supplementary Regulations.

24 RESPONSIBILITIES

Any problem or concern which arises regarding the rider or the third party is not the responsibility of the organiser, and the organiser can reject any claims of responsibility which may be laid upon him/her.

25 PREJUDICIAL ACTION

Any person having an interest in a rider's performance, who takes any action prejudicial to the sport, may result in the disqualification of that rider. Riders, parents or associates failing to obey the instructions given by officials of a meeting or deemed to have unjustifiably or maliciously jeopardised the efficient running of the meeting by not adhering to the Regulations, Supplementary Regulations or the Protest or appeal procedure, may render the rider liable for disqualification and/or being reported to the permit issuing authority for further action.

26 OFFENSIVE BEHAVIOUR

Any rider or party with an interest in a rider's performance, reported to the Clerk of the Course for arguing or being offensive to an Observer, or other Official, renders that rider eligible for disciplinary action. Where the organiser issues the Observer with a Red Card, any rider who is shown the "Red Card" by an Observer could be subjected to disqualification by the Clerk of the Course.

27 COMPLIANCE WITH REGULATIONS

Every rider by entering or being nominated thereby acknowledges that he is bound by the National Sporting Code of the ACU and these Standing Regulations and Final Instructions to be hereafter issued; to all of which he/she undertakes to submit and moreover renounces any right to have recourse to any arbitration or tribunal not provided for in the said Rules and Regulations.

28 INTERPRETATION

The interpretation of these Standing Regulations and the Supplementary Regulations or Instructions to rider will rest entirely with the Stewards of the Meeting whose decision shall be final and binding except as provided in the National Sporting Code.

29 ABANDONMENT

The organisers reserve the right, subject to the approval of the Stewards of the Meeting, to cancel, postpone or abandon the competition if circumstances should arise, which in their opinion render such action necessary.

30 POWER WASHERS

It is prohibited to use power washers, unless the organisers offer suitable facilities which comply with the ACU Environmental Code.

BIKETRIAL OBSERVING RULES

The time limit to complete a section is 2 minutes

No:		Point(s):
1	Not completing section within time limit	5
2	Performing a clean section	0
3	1 dab	1
4	2 alternate dabs	2
5	2 dabs at the same time	5
6	3 and 4 alternate dabs	3
7	5 or more dabs	5
8	Leaning the handlebar on any part of the section, e.g. the ground, tree or wall etc	1
9	Leaning one's hand on any part of the section, e.g. the ground, tree, wall etc	5
10	Leaning any part of the body on the ground, except feet	5
11	Re-crossing the start line and contacting outside with any part of bike after the front axle of bike has crossed the start line of the section (refer to Fig 1)	5
12	Overpassing the ribbon and contacting outside of the section with the tyre	5
13	One wheel flying over the ribbon without contacting the ground (refer to Fig 2)	0
14	Two wheels flying over the ribbon (refer to Fig 3)	5
15	Passing or treading on the ribbon with bike	0
16	Under passing the vertical line of the ribbon with the wheel axle (refer to Fig 4)	5
17	Both the front and rear wheel axles must pass between the colour signs, the ribbon and the stakes	5
18	If the front axle of the rider's bike crosses between colour sign which does not belong to the category of his own (refer to Fig 5)	5
19	Breaking a ribbon, pulling up or knocking down a stake	5
20	Knocking down colour signs	0
21	Touching any part of bike with hand except handlebar whilst dabbing	5
22	One dab on the ground and the other foot crossing the centre line of the bike frame	5
23	One foot on the pedal and the other foot crossing the centre line of the bike frame (refer to Fig 6)	0
24	One foot on the pedal and the crossing foot touching on any part of the section e.g. the ground, tree etc. (refer to Fig 6)	5
25	After one dab, sliding the foot on the ground (pivoting on the toes without gaining distance is allowed)	3
26	The sections cannot be modified by either the riders or any other person	10
27	Leaning with only the toes or heels on any surface (resting or touching the pedal is allowed)	1
28	Regarding objections or complaints, the Observer is only obliged to listen to the riders.	
	Any penalisation will be set through the Clerk of the Course	10
29	Any use of bad language directed at the Observer or other event officials, the penalisation will be set through the Clerk of the Course	0-50
30	Losing the penalisation card: the penalisation card is the only official medium to record the score in each section	10
31	The rider cannot receive any help from his relatives or friends such as giving them the penalisation card, asking them to carry the bike by foot or car, or observing section while their bike is queuing. (The riders riding the blue, blue with white and white colour routes will be allowed to receive the above mentioned help)	10-50

32	No person (spectator, relative) is allowed inside the section. Regarding the duties of the minder refer to “Limitations of the minder” (Item to be noted). The penalisation must be set through the Clerk of the Course	10
33	Taking a short-cut	10
34	Skipping a section. (The rider must perform the sections in numerical order)	10

Items to be noted:

- 35 Touching will be allowed, leaning will not. The bike can touch any part of the section (except the handlebar).
- 36 Going outside the boundary of the section with the bike in any manner is not allowed.
- 37 The parts which determine the bike limits are as follows:
- a) Frontal: Front wheel axle
 - b) Posterior: Rear wheel axle
 - c) Contact: Between tyre and the ground
- 38 The axle of the front wheel indicates the entry and the exit of a section.
- 39 The Observer will indicate the score to the riders by hand signals.
- 40 The rider must be equipped with the regulation clothing (long pants, helmet), otherwise the Observer will not allow him/her to enter the section (refer to Rider Clothing).

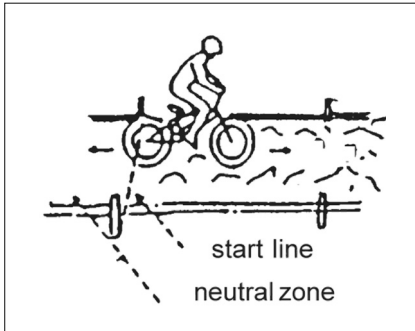

Fig 1

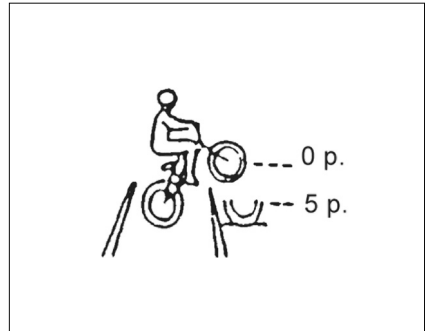

Fig 2

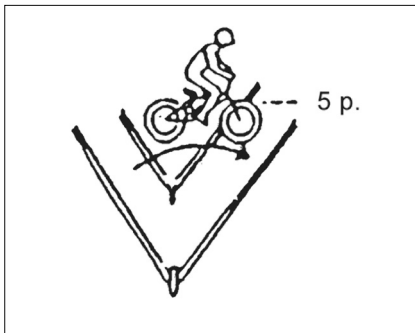

Fig 3

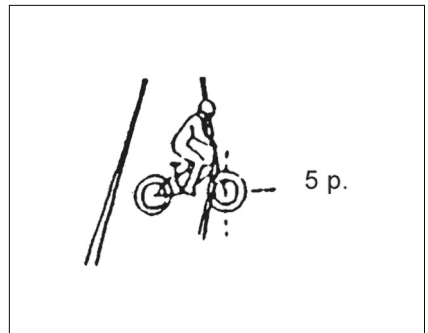

Fig 4

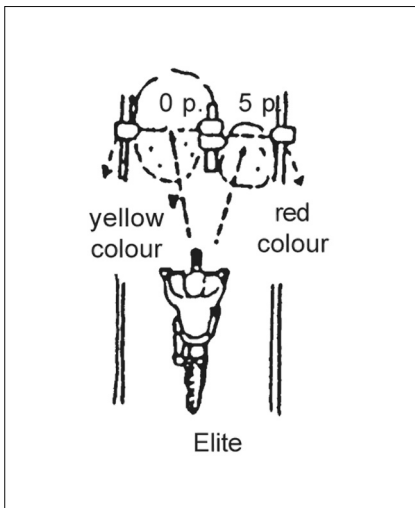

Fig 5

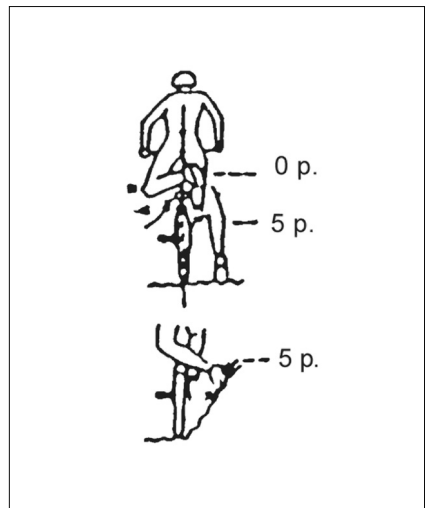

Fig 6